

**ANNEX I**

**SUMMARY OF PRODUCT CHARACTERISTICS**

Protected by Copyright

▼ This medicinal product is subject to additional monitoring. This will allow quick identification of new safety information. Healthcare professionals are asked to report any suspected adverse reactions. See section 4.8 for how to report adverse reactions.

## 1. NAME OF THE MEDICINAL PRODUCT

Wegovy 0.25 mg solution for injection in pre-filled pen  
Wegovy 0.5 mg solution for injection in pre-filled pen  
Wegovy 1 mg solution for injection in pre-filled pen  
Wegovy 1.7 mg solution for injection in pre-filled pen  
Wegovy 2.4 mg solution for injection in pre-filled pen  
Wegovy 0.25 mg FlexTouch solution for injection in pre-filled pen  
Wegovy 0.5 mg FlexTouch solution for injection in pre-filled pen  
Wegovy 1 mg FlexTouch solution for injection in pre-filled pen  
Wegovy 1.7 mg FlexTouch solution for injection in pre-filled pen  
Wegovy 2.4 mg FlexTouch solution for injection in pre-filled pen

## 2. QUALITATIVE AND QUANTITATIVE COMPOSITION

### Pre-filled pen, single-dose

#### Wegovy 0.25 mg solution for injection

Each single-dose pre-filled pen contains 0.25 mg semaglutide\* in 0.5 mL solution. One mL of solution contains 0.5 mg of semaglutide\*.

#### Wegovy 0.5 mg solution for injection

Each single-dose pre-filled pen contains 0.5 mg semaglutide\* in 0.5 mL solution. One mL of solution contains 1 mg of semaglutide\*.

#### Wegovy 1 mg solution for injection

Each single-dose pre-filled pen contains 1 mg semaglutide\* in 0.5 mL solution. One mL of solution contains 2 mg of semaglutide\*.

#### Wegovy 1.7 mg solution for injection

Each single-dose pre-filled pen contains 1.7 mg semaglutide\* in 0.75 mL solution. One mL of solution contains 2.27 mg of semaglutide\*.

#### Wegovy 2.4 mg solution for injection

Each single-dose pre-filled pen contains 2.4 mg semaglutide\* in 0.75 mL solution. One mL of solution contains 3.2 mg of semaglutide\*.

### Pre-filled pen, FlexTouch

#### Wegovy 0.25 mg FlexTouch solution for injection

Each pre-filled pen contains 1 mg semaglutide\* in 1.5 mL solution. One mL of solution contains 0.68 mg semaglutide\*. One pre-filled pen contains 4 doses of 0.25 mg.

#### Wegovy 0.5 mg FlexTouch solution for injection

Each pre-filled pen contains 2 mg semaglutide\* in 1.5 mL solution. One mL of solution contains 1.34 mg semaglutide\*. One pre-filled pen contains 4 doses of 0.5 mg.

#### Wegovy 1 mg FlexTouch solution for injection

Each pre-filled pen contains 4 mg semaglutide\* in 3 mL solution. One mL of solution contains 1.34 mg semaglutide\*. One pre-filled pen contains 4 doses of 1 mg.

Wegovy 1.7 mg FlexTouch solution for injection

Each pre-filled pen contains 6.8 mg semaglutide\* in 3 mL solution. One mL of solution contains 2.27 mg semaglutide\*. One pre-filled pen contains 4 doses of 1.7 mg.

Wegovy 2.4 mg FlexTouch solution for injection

Each pre-filled pen contains 9.6 mg semaglutide\* in 3 mL solution. One mL of solution contains 3.2 mg semaglutide\*. One pre-filled pen contains 4 doses of 2.4 mg.

\*human glucagon-like peptide-1 (GLP-1) analogue produced in *Saccharomyces cerevisiae* cells by recombinant DNA technology.

For the full list of excipients, see section 6.1.

### 3. PHARMACEUTICAL FORM

Solution for injection (injection)

Clear and colourless isotonic solution; pH=7.4.

### 4. CLINICAL PARTICULARS

#### 4.1 Therapeutic indications

##### Adults

Wegovy is indicated as an adjunct to a reduced-calorie diet and increased physical activity for weight management, including weight loss and weight maintenance, in adults with an initial Body Mass Index (BMI) of

- $\geq 30 \text{ kg/m}^2$  (obesity), or
- $\geq 27 \text{ kg/m}^2$  to  $< 30 \text{ kg/m}^2$  (overweight) in the presence of at least one weight-related comorbidity e.g. dysglycaemia (prediabetes or type 2 diabetes mellitus), hypertension, dyslipidaemia, obstructive sleep apnoea or cardiovascular disease.

##### Adolescents ( $\geq 12$ years)

Wegovy is indicated as an adjunct to a reduced-calorie diet and increased physical activity for weight management in adolescents ages 12 years and above with

- obesity\* and
- body weight above 60 kg.

Treatment with Wegovy should be discontinued and re-evaluated if adolescent patients have not reduced their BMI by at least 5% after 12 weeks on the 2.4 mg or maximum tolerated dose.

\*Obesity (BMI  $\geq 95^{\text{th}}$  percentile) as defined on sex- and age-specific BMI growth charts (CDC.gov) (see Table 1).

**Table 1 BMI cut-off points for obesity ( $\geq 95^{\text{th}}$  percentile) by sex and age for paediatric patients aged 12 and older (CDC criteria)**

Age (years)	BMI (kg/m <sup>2</sup> ) at 95th Percentile	
	Males	Females
12	24.2	25.2
12.5	24.7	25.7
13	25.1	26.3
13.5	25.6	26.8
14	26.0	27.2
14.5	26.4	27.7

Age (years)	BMI (kg/m <sup>2</sup> ) at 95th Percentile	
	Males	Females
15	26.8	28.1
15.5	27.2	28.5
16	27.5	28.9
16.5	27.9	29.3
17	28.2	29.6
17.5	28.6	30.0

## 4.2 Posology and method of administration

### Posology

#### Adults

The maintenance dose of semaglutide 2.4 mg once-weekly is reached by starting with a dose of 0.25 mg. To reduce the likelihood of gastrointestinal symptoms, the dose should be escalated over a 16-week period to a maintenance dose of 2.4 mg once weekly (see Table 2). In case of significant gastrointestinal symptoms, consider delaying dose escalation or lowering to the previous dose until symptoms have improved. Weekly doses higher than 2.4 mg are not recommended.

**Table 2 Dose escalation schedule**

Dose escalation	Weekly dose
Week 1–4	0.25 mg
Week 5–8	0.5 mg
Week 9–12	1 mg
Week 13–16	1.7 mg
<b>Maintenance dose</b>	<b>2.4 mg</b>

#### Adolescents

For adolescents ages 12 years and above, the same dose escalation schedule as for adults should be applied (see Table 2). The dose should be increased until 2.4 mg (maintenance dose) or maximum tolerated dose has been reached. Weekly doses higher than 2.4 mg are not recommended.

#### Patients with type 2 diabetes

When initiating semaglutide in patients with type 2 diabetes, consider reducing the dose of concomitantly administered insulin or insulin secretagogues (such as sulfonylureas) to reduce the risk of hypoglycaemia, see section 4.4.

#### Missed dose

If a dose is missed, it should be administered as soon as possible and within 5 days after the missed dose. If more than 5 days have passed, the missed dose should be skipped, and the next dose should be administered on the regularly scheduled day. In each case, patients can then resume their regular once weekly dosing schedule. If more doses are missed, reducing the starting dose for re-initiation should be considered.

#### Special populations

##### *Elderly (≥65 years old)*

No dose adjustment is required based on age. Therapeutic experience in patients ≥75 years of age is limited, and greater sensitivity of some older individuals cannot be excluded.

##### *Patients with renal impairment*

No dose adjustment is required for patients with mild or moderate renal impairment. Experience with the use of semaglutide in patients with severe renal impairment is limited. Semaglutide is not

recommended for use in patients with severe renal impairment (eGFR <30 mL/min/1.73m<sup>2</sup>) including patients with end-stage renal disease (see sections 4.4, 4.8 and 5.2).

#### *Patients with hepatic impairment*

No dose adjustment is required for patients with mild or moderate hepatic impairment. Experience with the use of semaglutide in patients with severe hepatic impairment is limited. Semaglutide is not recommended for use in patients with severe hepatic impairment and should be used cautiously in patients with mild or moderate hepatic impairment (see sections 4.4 and 5.2).

#### *Paediatric population*

No dose adjustment is required for adolescents ages 12 years and above.  
The safety and efficacy of semaglutide in children below 12 years of age have not been established.

#### Method of administration

Subcutaneous use.

Wegovy is administered once weekly at any time of the day, with or without meals.

It is to be injected subcutaneously in the abdomen, in the thigh or in the upper arm. The injection site can be changed. It should not be administered intravenously or intramuscularly.

The day of weekly administration can be changed if necessary, as long as the time between two doses is at least 3 days (>72 hours). After selecting a new dosing day, once-weekly dosing should be continued.

When administering Wegovy pre-filled pen for single use, the pen should be pressed firmly against the skin until the yellow bar has stopped moving. The injection takes about 5–10 seconds.

Patients should be advised to read the instruction for use included in the package leaflet carefully before administering the medicinal product.

For further information before administration see section 6.6.

### **4.3 Contraindications**

Hypersensitivity to the active substance or to any of the excipients listed in section 6.1.

### **4.4 Special warnings and precautions for use**

#### Traceability

In order to improve the traceability of biological medicinal products, the name and the batch number of the administered product should be clearly recorded.

#### Dehydration

Use of GLP-1 receptor agonists may be associated with gastrointestinal adverse reactions that can cause dehydration, which in rare cases can lead to a deterioration of renal function.

Patients should be advised of the potential risk of dehydration in relation to gastrointestinal side effects and take precautions to avoid fluid depletion.

#### Acute pancreatitis

Acute pancreatitis has been observed with the use of GLP-1 receptor agonists (see section 4.8). Patients should be informed of the characteristic symptoms of acute pancreatitis. If pancreatitis is

suspected, semaglutide should be discontinued; if confirmed, semaglutide should not be restarted. Caution should be exercised in patients with a history of pancreatitis. In the absence of other signs and symptoms of acute pancreatitis, elevations in pancreatic enzymes alone are not predictive of acute pancreatitis.

#### Patients with type 2 diabetes

Semaglutide should not be used as a substitute for insulin in patients with type 2 diabetes.

Semaglutide should not be used in combination with other GLP-1 receptor agonist products. It has not been evaluated and an increased risk of adverse reactions related to overdose is considered likely.

#### Hypoglycaemia in patients with type 2 diabetes

Insulin and sulfonylurea are known to cause hypoglycaemia. Patients treated with semaglutide in combination with a sulfonylurea or insulin may have an increased risk of hypoglycaemia. The risk of hypoglycaemia can be lowered by reducing the dose of sulfonylurea or insulin when initiating treatment with a GLP-1 receptor agonist. The addition of Wegovy in patients treated with insulin has not been evaluated.

#### Diabetic retinopathy in patients with type 2 diabetes

In patients with diabetic retinopathy treated with semaglutide, an increased risk of developing diabetic retinopathy complications has been observed (see section 4.8). Rapid improvement in glucose control has been associated with a temporary worsening of diabetic retinopathy, but other mechanisms cannot be excluded. Patients with diabetic retinopathy using semaglutide should be monitored closely and treated according to clinical guidelines. There is no experience with Wegovy in patients with type 2 diabetes with uncontrolled or potentially unstable diabetic retinopathy. In these patients, treatment with Wegovy is not recommended.

#### Populations not studied

The safety and efficacy of Wegovy have not been investigated in patients:

- treated with other products for weight management,
- with type 1 diabetes,
- with severe renal impairment (see section 4.2),
- with severe hepatic impairment (see section 4.2),
- with congestive heart failure New York Heart Association (NYHA) class IV.

Use in these patients is not recommended.

There is limited experience with Wegovy in patients:

- aged 75 years or more (see section 4.2),
- with mild or moderate hepatic impairment (see section 4.2),
- with inflammatory bowel disease,
- with diabetic gastroparesis.

Use with caution in these patients.

#### Sodium content

This medicinal product contains less than 1 mmol sodium (23 mg) per dose, that is to say essentially 'sodium-free'.

### **4.5 Interaction with other medicinal products and other forms of interaction**

Semaglutide delays gastric emptying and could potentially influence the absorption of concomitantly administered oral medicinal products. No clinically relevant effect on the rate of gastric emptying was observed with semaglutide 2.4 mg, probably due to a tolerance effect. Semaglutide should be used

with caution in patients receiving oral medicinal products that require rapid gastrointestinal absorption.

#### Paracetamol

Semaglutide delays the rate of gastric emptying as assessed by paracetamol pharmacokinetics during a standardised meal test. Paracetamol  $AUC_{0-60min}$  and  $C_{max}$  were decreased by 27% and 23%, respectively, following concomitant use of semaglutide 1 mg. The total paracetamol exposure ( $AUC_{0-5h}$ ) was not affected. No clinically relevant effect on paracetamol was observed with semaglutide. No dose adjustment of paracetamol is necessary when administered with semaglutide.

#### Oral contraceptives

Semaglutide is not anticipated to decrease the effectiveness of oral contraceptives. It did not change the overall exposure of ethinylestradiol and levonorgestrel to a clinically relevant degree, when an oral contraceptive combination medicinal product (0.03 mg ethinylestradiol/0.15 mg levonorgestrel) was co-administered with semaglutide. Exposure of ethinylestradiol was not affected; an increase of 20% was observed for levonorgestrel exposure at steady state.  $C_{max}$  was not affected for any of the compounds.

#### Atorvastatin

Semaglutide did not change the overall exposure of atorvastatin following a single dose administration of atorvastatin (40 mg). Atorvastatin  $C_{max}$  was decreased by 38%. This was assessed not to be clinically relevant.

#### Digoxin

Semaglutide did not change the overall exposure or  $C_{max}$  of digoxin following a single dose of digoxin (0.5 mg).

#### Metformin

Semaglutide did not change the overall exposure or  $C_{max}$  of metformin following dosing of 500 mg twice daily over 3.5 days.

#### Warfarin

Semaglutide did not change overall exposure or  $C_{max}$  of R- and S-warfarin following a single dose of warfarin (25 mg), and the pharmacodynamic effects of warfarin as measured by the international normalised ratio were not affected in a clinically relevant manner. However, upon initiation of semaglutide treatment in patients on warfarin or other coumarin derivatives, frequent monitoring of international normalised ratio (INR) is recommended.

#### Paediatric population

Interaction studies have only been performed in adults.

### **4.6 Fertility, pregnancy and lactation**

#### Women of childbearing potential

Women of childbearing potential are recommended to use contraception when treated with semaglutide (see section 4.5).

### Pregnancy

Studies in animals have shown reproductive toxicity (see section 5.3). There are limited data from the use of semaglutide in pregnant women. Therefore, semaglutide should not be used during pregnancy. If a patient wishes to become pregnant, or pregnancy occurs, semaglutide should be discontinued. Semaglutide should be discontinued at least 2 months before a planned pregnancy due to the long half-life (see section 5.2).

### Breast-feeding

In lactating rats, semaglutide was excreted in milk. A risk to a breast-fed child cannot be excluded. Semaglutide should not be used during breast-feeding.

### Fertility

The effect of semaglutide on fertility in humans is unknown. Semaglutide did not affect male fertility in rats. In female rats, an increase in oestrous length and a small reduction in number of ovulations were observed at doses associated with maternal body weight loss.

## **4.7 Effects on ability to drive and use machines**

Semaglutide has no or negligible influence on the ability to drive or use machines. However, dizziness can be experienced mainly during the dose escalation period. Driving or use of machines should be done cautiously if dizziness occurs.

### Patients with type 2 diabetes

If semaglutide is used in combination with a sulfonylurea or insulin, patients should be advised to take precautions to avoid hypoglycaemia while driving and using machines (see section 4.4).

## **4.8 Undesirable effects**

### Summary of safety profile

In four phase 3a trials, 2,650 adult patients were exposed to Wegovy. The duration of the trials were 68 weeks. The most frequently reported adverse reactions were gastrointestinal disorders including nausea, diarrhoea, constipation and vomiting.

### Tabulated list of adverse reactions

Table 3 lists adverse reactions identified in phase 3a clinical trials in adults. The frequencies are based on a pool of the phase 3a trials.

Adverse reactions associated with Wegovy are listed by system organ class and frequency. Frequency categories are defined as: Very common ( $\geq 1/10$ ); common ( $\geq 1/100$  to  $< 1/10$ ); uncommon ( $\geq 1/1000$  to  $< 1/100$ ); rare ( $\geq 1/10000$  to  $< 1/1000$ ); very rare ( $< 1/10000$ ).

**Table 3 Adverse reactions from controlled phase 3 trials in adults**

<b>MedDRA system organ class</b>	<b>Very common</b>	<b>Common</b>	<b>Uncommon</b>	<b>Rare</b>
Immune system disorders				Anaphylactic reaction
Metabolism and nutrition disorders		Hypoglycaemia in patients with type 2 diabetes <sup>a</sup>		
Nervous system disorders	Headache <sup>b</sup>	Dizziness <sup>b</sup>		



MedDRA system organ class	Very common	Common	Uncommon	Rare
Eye disorders		Diabetic retinopathy in patients with type 2 diabetes <sup>a</sup>		
Cardiac disorders			Hypotension Orthostatic hypotension Increased heart rate <sup>a,c</sup>	
Gastrointestinal disorders	Vomiting <sup>a,b</sup> Diarrhoea <sup>a,b</sup> Constipation <sup>a,b</sup> Nausea <sup>a,b</sup> Abdominal pain <sup>b,c</sup>	Gastritis <sup>b,c</sup> Gastrooesophageal reflux disease <sup>b</sup> Dyspepsia <sup>b</sup> Eructation <sup>b</sup> Flatulence <sup>b</sup> Abdominal distension <sup>b</sup>	Acute pancreatitis <sup>a</sup> Delayed gastric emptying	
Hepatobiliary disorders		Cholelithiasis <sup>a</sup>		
Skin and subcutaneous tissue disorders		Hair loss <sup>a</sup>		Angioedema
General disorders and administration site conditions	Fatigue <sup>b,c</sup>	Injection site reactions <sup>c</sup>		
Investigations			Increased amylase <sup>c</sup> Increased lipase <sup>c</sup>	

<sup>a)</sup> see description of selected adverse reactions below

<sup>b)</sup> mainly seen in the dose-escalation period

<sup>c)</sup> Grouped preferred terms

### Description of selected adverse reactions

#### Gastrointestinal adverse reactions

Over the 68 weeks trial period, nausea occurred in 43.9% of patients when treated with semaglutide (16.1% for placebo), diarrhoea in 29.7% (15.9% for placebo) and vomiting in 24.5% (6.3% for placebo). Most events were mild to moderate in severity and of short duration. Constipation occurred in 24.2% of patients treated with semaglutide (11.1% for placebo) and was mild to moderate in severity and of longer duration. In patients treated with semaglutide, median duration of nausea was 8 days, vomiting 2 days, diarrhoea 3 days, and constipation 47 days.

Patients with moderate renal impairment (eGFR  $\geq 30$  mL/min/1.73m<sup>2</sup>) may experience more gastrointestinal effects when treated with semaglutide.

The gastrointestinal events led to permanent treatment discontinuation in 4.3% of patients.

#### Acute pancreatitis

The frequency of adjudication-confirmed acute pancreatitis reported in phase 3a clinical trials was 0.2% for semaglutide and <0.1% for placebo, respectively.

#### Acute gallstone disease/Cholelithiasis

Cholelithiasis was reported in 1.6% and led to cholecystitis in 0.6% of patients treated with semaglutide. Cholelithiasis and cholecystitis was reported in 1.1% and 0.3%, respectively, of patients treated with placebo.

### Hair loss

Hair loss was reported in 2.5% of patients treated with semaglutide and in 1.0% of patients treated with placebo. The events were mainly of mild severity and most patients recovered while on continued treatment. Hair loss was reported more frequently in patients with a greater weight loss ( $\geq 20\%$ ).

### Increased heart rate

In the phase 3a trials, a mean increase of 3 beats per minute (bpm) from a baseline mean of 72 bpm was observed in patients treated with semaglutide. The proportions of subjects with an increase in pulse from baseline  $\geq 10$  bpm at any timepoint during the on-treatment period were 67.0% in the semaglutide group vs. 50.1% in the placebo group.

### Immunogenicity

Consistent with the potentially immunogenic properties of medicinal products containing proteins or peptides, patients may develop antibodies following treatment with semaglutide. The proportion of patients testing positive for anti-semaglutide antibodies at any time post-baseline was low (2.9%) and no patients had anti-semaglutide neutralising antibodies or anti-semaglutide antibodies with endogenous GLP-1 neutralising effect at end-of-trial. During treatment, high semaglutide concentrations might have lowered the sensitivity of the assays, hence the risk of false negatives cannot be excluded. However, in subjects testing positive for antibodies during and after treatment, the presence of antibodies was transient and with no apparent impact on efficacy and safety.

### Hypoglycaemia in patients with type 2 diabetes

In STEP 2, clinically significant hypoglycaemia was observed in 6.2% (0.1 events/patient year) of subjects treated with semaglutide compared with 2.5% (0.03 events/patient year) of subjects treated with placebo. Hypoglycaemia with semaglutide was seen both with and without concomitant use of sulfonylurea. One episode (0.2% of subjects, 0.002 events/patient year) was reported as severe in a subject not concomitantly treated with a sulfonylurea. The risk of hypoglycaemia was increased when semaglutide was used with a sulfonylurea.

### Diabetic retinopathy in patients with type 2 diabetes

A 2-year clinical trial investigated semaglutide 0.5 mg and 1 mg vs. placebo in 3,297 patients with type 2 diabetes, with high cardiovascular risk, long duration of diabetes and poorly controlled blood glucose. In this trial, adjudicated events of diabetic retinopathy complications occurred in more patients treated with semaglutide (3.0%) compared to placebo (1.8%). This was observed in insulin-treated patients with known diabetic retinopathy. The treatment difference appeared early and persisted throughout the trial. In STEP 2, retinal disorders were reported by 6.9% of patients treated with Wegovy, 6.2% of patients treated with semaglutide 1 mg, and 4.2% of patients treated with placebo. The majority of events were reported as diabetic retinopathy (4.0%, 2.7%, and 2.7%, respectively) and non-proliferative retinopathy (0.7%, 0%, and 0%, respectively).

### Paediatric population

In a clinical trial conducted in adolescents of 12 years to below 18 years with obesity or overweight with at least one weight-related comorbidity, 133 patients were exposed to Wegovy. The trial duration was 68 weeks.

Overall, the frequency, type and severity of adverse reactions in the adolescents were comparable to that observed in the adult population. Cholelithiasis was reported in 3.8% of patients treated with Wegovy and 0% of patients treated with placebo.

No effects on growth or pubertal development were found after 68 weeks of treatment.

### Reporting of suspected adverse reactions

Reporting suspected adverse reactions after authorisation of the medicinal product is important. It allows continued monitoring of the benefit/risk balance of the medicinal product. Healthcare

professionals are asked to report any suspected adverse reactions via the national reporting system listed in [Appendix V](#).

#### 4.9 Overdose

Overdose with semaglutide may be associated with gastrointestinal disorders which could lead to dehydration. In the event of overdose the patient should be observed for clinical signs and appropriate supportive treatment initiated.

### 5. PHARMACOLOGICAL PROPERTIES

#### 5.1 Pharmacodynamic properties

Pharmacotherapeutic group: Drugs used in diabetes, glucagon-like peptide-1 (GLP-1) analogues, ATC code: A10BJ06

##### Mechanism of action

Semaglutide is a GLP-1 analogue with 94% sequence homology to human GLP-1. Semaglutide acts as a GLP-1 receptor agonist that selectively binds to and activates the GLP-1 receptor, the target for native GLP-1.

GLP-1 is a physiological regulator of appetite and calorie intake, and the GLP-1 receptor is present in several areas of the brain involved in appetite regulation.

Animal studies show that semaglutide works in the brain through the GLP-1 receptor. Semaglutide has direct effects on areas in the brain involved in homeostatic regulation of food intake in the hypothalamus and the brainstem. Semaglutide may affect the hedonic reward system through direct and indirect effects in brain areas including the septum, thalamus and amygdala.

Clinical studies show that semaglutide reduces energy intake, increases feelings of satiety, fullness and control of eating, reduces feelings of hunger, and frequency and intensity of cravings. In addition, semaglutide reduces the preference for high fat foods.

Semaglutide orchestrates the homeostatic and hedonic contributions with executive function to regulate caloric intake, appetite, reward and food choice.

In addition, in clinical studies semaglutide have shown to reduce blood glucose in a glucose dependent manner by stimulating insulin secretion and lowering glucagon secretion when blood glucose is high. The mechanism of blood glucose lowering also involves a minor delay in gastric emptying in the early postprandial phase. During hypoglycaemia, semaglutide diminishes insulin secretion and does not impair glucagon secretion.

GLP-1 receptors are also expressed in the heart, vasculature, immune system and kidneys. Semaglutide has a beneficial effect on plasma lipids, lowered systolic blood pressure and reduced inflammation in clinical studies. Furthermore, animal studies have shown that semaglutide attenuated the development of atherosclerosis and had an anti-inflammatory action in the cardiovascular system.

##### Pharmacodynamic effects

###### *Appetite, energy intake and food choice*

Semaglutide reduces appetite by increasing feelings of fullness and satiety, while lowering hunger and prospective food consumption. In a phase 1 trial, energy intake during an ad libitum meal was 35% lower with semaglutide compared to placebo after 20 weeks of dosing. This was supported by improved control of eating, less food cravings and a relative lower preference for high fat food. Food cravings were further assessed in STEP 5 by a Control of Eating Questionnaire (CoEQ). At week 104,

the estimated treatment difference both for control of cravings and craving of savoury food significantly favoured semaglutide, whereas no clear effect was seen for craving of sweet food.

#### Fasting and postprandial lipids

Semaglutide 1 mg compared to placebo lowered fasting triglyceride and very low density lipoproteins (VLDL) concentrations by 12% and 21%, respectively. The postprandial triglyceride and VLDL response to a high fat meal was reduced with >40%.

#### Clinical efficacy and safety

The efficacy and safety of semaglutide for weight management in combination with a reduced calorie intake and increased physical activity were evaluated in four 68 weeks double-blinded randomised placebo-controlled phase 3a trials (STEP 1-4). A total of 4,684 adult patients (2,652 randomised to treatment with semaglutide) were included in these trials. Furthermore, the two-year efficacy and safety of semaglutide compared to placebo were evaluated in a double-blinded randomised placebo-controlled phase 3b trial (STEP 5) including 304 patients (152 in treatment with semaglutide).

Treatment with semaglutide demonstrated superior, clinically meaningful, and sustained weight loss compared with placebo in patients with obesity (BMI  $\geq 30$  kg/m<sup>2</sup>), or overweight (BMI  $\geq 27$  kg/m<sup>2</sup> to  $< 30$  kg/m<sup>2</sup>) and at least one weight-related comorbidity. Furthermore, across the trials, a higher proportion of patients achieved  $\geq 5\%$ ,  $\geq 10\%$ ,  $\geq 15\%$  and  $\geq 20\%$  weight loss with semaglutide compared with placebo. The reduction in body weight occurred irrespective of the presence of gastrointestinal symptoms such as nausea, vomiting or diarrhoea.

Treatment with semaglutide also showed statistically significant improvements in waist circumference, systolic blood pressure and physical functioning compared to placebo.

Efficacy was demonstrated regardless of age, sex, race, ethnicity, baseline body weight, BMI, presence of type 2 diabetes and level of renal function. Variations in efficacy existed within all subgroups. Relatively greater weight loss was observed in women and in patients without type 2 diabetes as well as in patients with a lower versus higher baseline body weight.

#### STEP 1: Weight management

In a 68-week double-blind trial, 1,961 patients with obesity (BMI  $\geq 30$  kg/m<sup>2</sup>), or with overweight (BMI  $\geq 27$  kg/m<sup>2</sup> to  $< 30$  kg/m<sup>2</sup>) and at least one weight-related comorbidity were randomised to semaglutide or placebo. All patients were on a reduced-calorie diet and increased physical activity throughout the trial.

Weight loss occurred early and continued throughout the trial. At end of treatment (week 68), the weight loss was superior and clinically meaningful compared with placebo (see Table 4 and Figure 1). Furthermore, a higher proportion of patients achieved  $\geq 5\%$ ,  $\geq 10\%$ ,  $\geq 15\%$  and  $\geq 20\%$  weight loss with semaglutide compared with placebo (see Table 4). Among patients with prediabetes at baseline, a higher proportion of patients had a normo-glycaemic status at end of treatment with semaglutide compared to placebo (84.1% vs. 47.8%).

**Table 4 STEP 1: Results at week 68**

	Wegovy	Placebo
Full analysis set (N)	1,306	655
<b>Body weight</b>		
Baseline (kg)	105.4	105.2
Change (%) from baseline <sup>1,2</sup>	-14.9	-2.4
Difference (%) from placebo <sup>1</sup> [95% CI]	-12.4 [-13.4; -11.5]*	-
Change (kg) from baseline	-15.3	-2.6
Difference (kg) from placebo <sup>1</sup> [95% CI]	-12.7 [-13.7; -11.7]	-
Patients (%) achieving weight loss $\geq 5\%$ <sup>3</sup>	83.5*	31.1
Patients (%) achieving weight loss $\geq 10\%$ <sup>3</sup>	66.1*	12.0
Patients (%) achieving weight loss $\geq 15\%$ <sup>3</sup>	47.9*	4.8
<b>Waist circumference (cm)</b>		
Baseline	114.6	114.8
Change from baseline <sup>1</sup>	-13.5	-4.1
Difference from placebo <sup>1</sup> [95% CI]	-9.4 [-10.3; -8.5]*	-
<b>Systolic blood pressure (mmHg)</b>		
Baseline	126	127
Change from baseline <sup>1</sup>	-6.2	-1.1
Difference from placebo <sup>1</sup> [95% CI]	-5.1 [-6.3; -3.9]*	-

\*p<0.0001 (unadjusted 2-sided) for superiority.

<sup>1</sup> Estimated using an ANCOVA model using multiple imputation based on all data irrespective of discontinuation of randomised treatment or initiation of other anti-obesity medication or bariatric surgery.

<sup>2</sup> During the trial, randomised treatment was permanently discontinued by 17.1% and 22.4% of patients randomised to semaglutide 2.4 mg and placebo, respectively. Assuming that all randomised patients stayed on treatment and did not receive additional anti-obesity therapies, the estimated changes from randomisation to week 68 for body weight based on a Mixed Model for Repeated Measures including all observations until first discontinuation were -16.9% and -2.4% for semaglutide 2.4 mg and placebo respectively.

<sup>3</sup> Estimated from binary regression model based on same imputation procedure as in primary analysis.

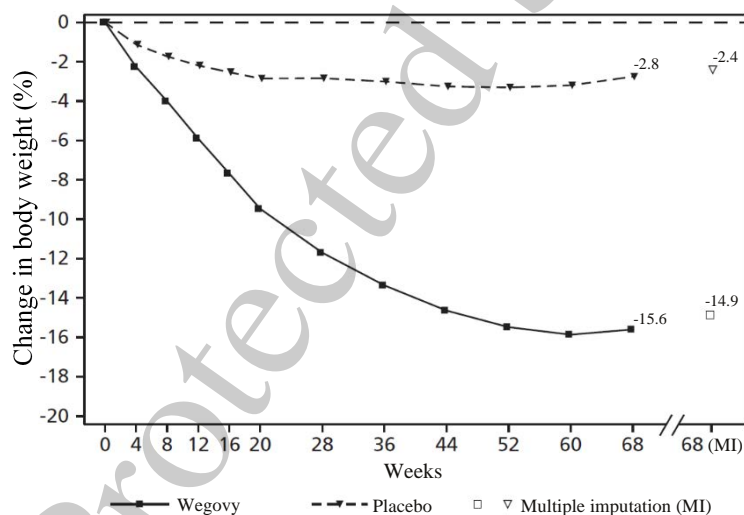

Observed values for patients completing each scheduled visit, and estimates with multiple imputations (MI) from retrieved dropouts

**Figure 1 STEP 1: Mean change in body weight (%) from baseline to week 68**

Following the 68-week trial, a 52-week off-treatment extension was conducted including 327 patients who had completed the main trial period on the maintenance dose of semaglutide or placebo. In the off-treatment period from week 68 to week 120, mean body weight increased in both treatment groups. However, for patients that had been treated with semaglutide for the main trial period the weight remained 5.6% below baseline compared to 0.1% for the placebo group.

**STEP 2: Weight management in patients with type 2 diabetes**

In a 68-week, double-blind trial, 1,210 patients with overweight or obesity (BMI  $\geq 27$  kg/m<sup>2</sup>) and type 2 diabetes were randomised to either semaglutide 2.4 mg, semaglutide 1 mg once-weekly or placebo. Patients included in the trial had insufficiently controlled diabetes (HbA<sub>1c</sub> 7–10%) and were treated with either: diet and exercise alone or 1–3 oral antidiabetic drugs. All patients were on a reduced-calorie diet and increased physical activity throughout the trial.

Treatment with semaglutide for 68 weeks resulted in superior and clinically meaningful reduction in body weight and in HbA<sub>1c</sub> compared to placebo (see Table 5 and Figure 2).

**Table 5 STEP 2: Results at week 68**

	<b>Wegovy</b>	<b>Placebo</b>
Full analysis set (N)	404	403
<b>Body weight</b>		
Baseline (kg)	99.9	100.5
Change (%) from baseline <sup>1,2</sup>	-9.6	-3.4
Difference (%) from placebo <sup>1</sup> [95% CI]	-6.2 [-7.3;-5.2]*	-
Change (kg) from baseline	-9.7	-3.5
Difference (kg) from placebo <sup>1</sup> [95% CI]	-6.1 [-7.2;-5.0]	-
Patients (%) achieving weight loss $\geq 5\%$ <sup>3</sup>	67.4*	30.2
Patients (%) achieving weight loss $\geq 10\%$ <sup>3</sup>	44.5*	10.2
Patients (%) achieving weight loss $\geq 15\%$ <sup>3</sup>	25.0*	4.3
<b>Waist circumference (cm)</b>		
Baseline	114.5	115.5
Change from baseline <sup>1</sup>	-9.4	-4.5
Difference from placebo <sup>1</sup> [95% CI]	-4.9 [-6.0; -3.8]*	-
<b>Systolic blood pressure (mmHg)</b>		
Baseline	130	130
Change from baseline <sup>1</sup>	-3.9	-0.5
Difference from placebo <sup>1</sup> [95% CI]	-3.4 [-5.6; -1.3]**	-
<b>HbA<sub>1c</sub> (mmol/mol (%))</b>		
Baseline	65.3 (8.1)	65.3 (8.1)
Change from baseline <sup>1</sup>	-17.5 (-1.6)	-4.1 (-0.4)
Difference from placebo <sup>1</sup> [95% CI]	-13.5 [-15.5; -11.4] (-1.2 [-1.4; -1.1])*	-

\* p<0.0001 (unadjusted 2-sided) for superiority; \*\*p<0.05 (unadjusted 2-sided) for superiority.

<sup>1</sup> Estimated using an ANCOVA model using multiple imputation based on all data irrespective of discontinuation of randomised treatment or initiation of other anti-obesity medication or bariatric surgery.

<sup>2</sup> During the trial, randomised treatment was permanently discontinued by 11.6% and 13.9% of patients randomised to semaglutide 2.4 mg and placebo, respectively. Assuming that all randomised patients stayed on treatment and did not receive additional anti-obesity therapies, the estimated changes from randomisation to week 68 for body weight based on a Mixed Model for Repeated Measures including all observations until first discontinuation were -10.6% and -3.1% for semaglutide 2.4 mg and placebo respectively

<sup>3</sup> Estimated from binary regression model based on same imputation procedure as in primary analysis.

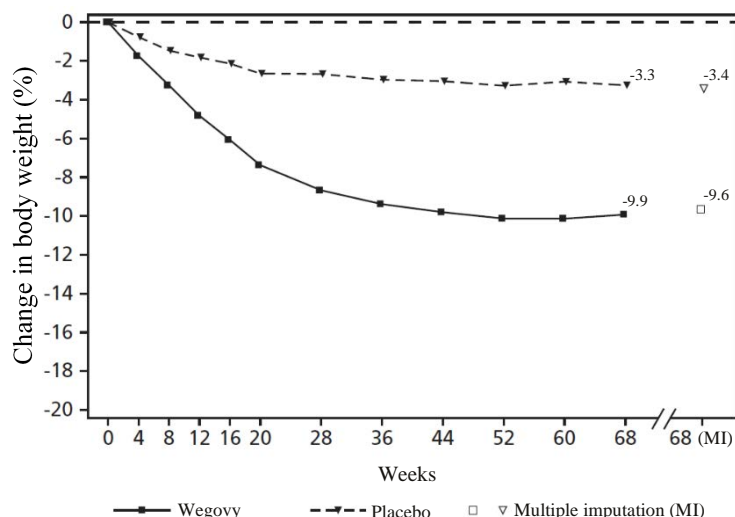

Observed values for patients completing each scheduled visit, and estimates with multiple imputations (MI) from retrieved dropouts

Figure 2 STEP 2: Mean change in body weight (%) from baseline to week 68

**STEP 3: Weight management with intensive behavioural therapy**

In a 68-week double-blind trial, 611 patients with obesity (BMI  $\geq 30$  kg/m<sup>2</sup>), or with overweight (BMI  $\geq 27$  kg/m<sup>2</sup> to  $< 30$  kg/m<sup>2</sup>) and at least one weight-related comorbidity were randomised to semaglutide or placebo. During the trial, all patients received intensive behavioural therapy (IBT) consisting of a very restrictive diet, increased physical activity and behavioural counselling.

Treatment with semaglutide and IBT for 68 weeks resulted in superior and clinically meaningful reduction in body weight compared to placebo (see Table 6).

**Table 6 STEP 3: Results at week 68**

	Wegovy	Placebo
Full analysis set (N)	407	204
<b>Body weight</b>		
Baseline (kg)	106.9	103.7
Change (%) from baseline <sup>1,2</sup>	-16.0	-5.7
Difference (%) from placebo <sup>1</sup> [95% CI]	-10.3 [-12.0; -8.6]*	-
Change (kg) from baseline	-16.8	-6.2
Difference (kg) from placebo <sup>1</sup> [95% CI]	-10.6 [-12.5; -8.8]	-
Patients (%) achieving weight loss $\geq 5\%$ <sup>3</sup>	84.8*	47.8
Patients (%) achieving weight loss $\geq 10\%$ <sup>3</sup>	73.0*	27.1
Patients (%) achieving weight loss $\geq 15\%$ <sup>3</sup>	53.5*	13.2
<b>Waist circumference (cm)</b>		
Baseline	113.6	111.8
Change from baseline <sup>1</sup>	-14.6	-6.3
Difference from placebo <sup>1</sup> [95% CI]	-8.3 [-10.1; -6.6]*	-
<b>Systolic blood pressure (mmHg)</b>		
Baseline	124	124
Change from baseline <sup>1</sup>	-5.6	-1.6
Difference from placebo <sup>1</sup> [95% CI]	-3.9 [-6.4; -1.5]*	-

\* p<0.005 (unadjusted 2-sided) for superiority.

<sup>1</sup> Estimated using an ANCOVA model using multiple imputation based on all data irrespective of discontinuation of randomised treatment or initiation of other anti-obesity medication or bariatric surgery.

<sup>2</sup> During the trial, randomised treatment was permanently discontinued by 16.7% and 18.6% of patients randomised to semaglutide 2.4 mg and placebo, respectively. Assuming that all randomised patients stayed on treatment and did not receive additional anti-obesity therapies, the estimated changes from randomisation to week 68 for body weight based on a Mixed

Model for Repeated Measures including all observations until first discontinuation were -17.6% and -5.0% for semaglutide 2.4 mg and placebo respectively

<sup>3</sup> Estimated from binary regression model based on same imputation procedure as in primary analysis.

***STEP 4: Sustained weight management***

In a 68-week double-blind trial, 902 patients with obesity (BMI  $\geq 30$  kg/m<sup>2</sup>), or with overweight (BMI  $\geq 27$  kg/m<sup>2</sup> to  $< 30$  kg/m<sup>2</sup>) and at least one weight-related comorbidity were included in the trial. All patients were on a reduced-calorie diet and increased physical activity throughout the trial. From week 0 to week 20 (run-in), all patients received semaglutide. At week 20 (baseline), patients who had reached the maintenance dose of 2.4 mg were randomised to continue treatment or switch to placebo. At week 0 (start of run-in period) patients had a mean body weight of 107.2 kg and a mean BMI of 38.4 kg/m<sup>2</sup>.

Patients who had reached the maintenance dose of 2.4 mg at week 20 (baseline) and continued treatment with semaglutide for 48 weeks (week 20–68) continued losing weight and had a superior and clinically meaningful reduction in body weight compared to those switched to placebo (see Table 7 and Figure 3). The body weight increased steadily from week 20 to week 68 in patients switching to placebo at week 20 (baseline). Nevertheless, the observed mean body weight was lower at week 68 than at start of the run-in period (week 0) (see Figure 3). Patients treated with semaglutide from week 0 (run-in) to week 68 (end of treatment) achieved a mean change in body weight of -17.4%, with weight loss  $\geq 5\%$  achieved by 87.8%,  $\geq 10\%$  achieved by 78.0%,  $\geq 15\%$  achieved by 62.2% and  $\geq 20\%$  achieved by 38.6% of these patients.

**Table 7 STEP 4: Results from week 20 to week 68**

	<b>Wegovy</b>	<b>Placebo</b>
Full analysis set (N)	535	268
<b>Body weight</b>		
Baseline <sup>1</sup> (kg)	96.5	95.4
Change (%) from baseline <sup>1,2,3</sup>	-7.9	6.9
Difference (%) from placebo <sup>2</sup> [95% CI]	-14.8 [-16.0; -13.5]*	-
Change (kg) from baseline	-7.1	6.1
Difference (kg) from placebo <sup>2</sup> [95% CI]	-13.2 [-14.3; -12.0]	-
<b>Waist circumference (cm)</b>		
Baseline	105.5	104.7
Change from baseline <sup>1</sup>	-6.4	3.3
Difference from placebo <sup>2</sup> [95% CI]	-9.7 [-10.9; -8.5]*	-
<b>Systolic blood pressure (mmHg)</b>		
Baseline <sup>1</sup>	121	121
Change from baseline <sup>1,2</sup>	0.5	4.4
Difference from placebo <sup>2</sup> [95% CI]	-3.9 [-5.8; -2.0]*	-

\*  $p < 0.0001$  (unadjusted 2-sided) for superiority.

<sup>1</sup> Baseline = week 20

<sup>2</sup> Estimated using an ANCOVA model using multiple imputation based on all data irrespective of discontinuation of randomised treatment or initiation of other anti-obesity medication or bariatric surgery.

<sup>3</sup> During the trial, randomised treatment was permanently discontinued by 5.8% and 11.6% of patients randomized to semaglutide 2.4 mg and placebo, respectively. Assuming that all randomised patients stayed on treatment and did not receive additional anti-obesity therapies, the estimated changes from randomisation to week 68 for body weight based on a Mixed Model for Repeated Measures including all observations until first discontinuation were -8.1% and 6.5% for semaglutide 2.4 mg and placebo respectively.



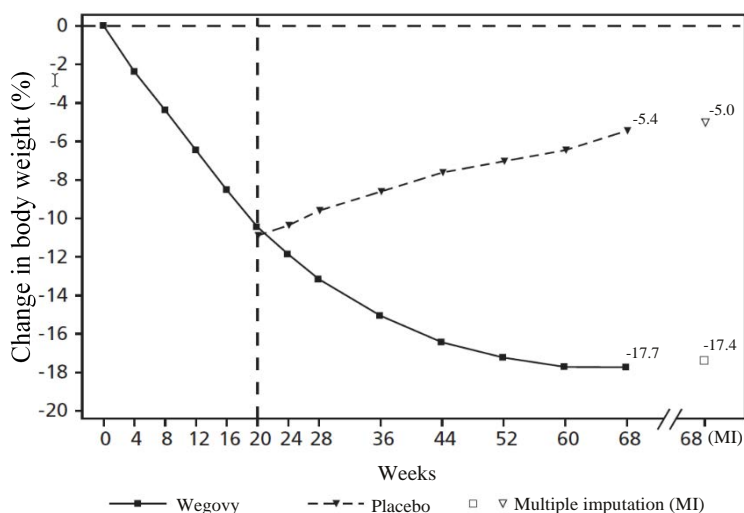

Observed values for patients completing each scheduled visit, and estimates with multiple imputations (MI) from retrieved dropouts  
Figure 3 STEP 4: Mean change in body weight (%) from week 0 to week 68

#### STEP 5: 2-year data

In a 104-week double-blind trial, 304 patients with obesity ( $\text{BMI} \geq 30 \text{ kg/m}^2$ ), or with overweight ( $\text{BMI} \geq 27$  to  $< 30 \text{ kg/m}^2$ ) and at least one weight-related comorbidity, were randomised to semaglutide or placebo. All patients were on a reduced-calorie diet and increased physical activity throughout the trial. At baseline, patients had a mean BMI of  $38.5 \text{ kg/m}^2$ , a mean body weight of 106.0 kg.

Treatment with semaglutide for 104 weeks resulted in a superior and clinically meaningful reduction in body weight compared to placebo. Mean body weight decreased from baseline through to week 68 with semaglutide after which a plateau was reached. With placebo, mean body weight decreased less, and a plateau was reached after approximately 20 weeks of treatment (see Table 8 and Figure 4). Patients treated with semaglutide achieved a mean change in body weight of -15.2%, with weight loss  $\geq 5\%$  achieved by 74.7%,  $\geq 10\%$  achieved by 59.2% and  $\geq 15\%$  achieved by 49.7% of these patients. Among patients with prediabetes at baseline, 80% and 37% achieved a normo-glycaemic status at end of treatment with semaglutide and placebo, respectively.

**Table 8 STEP 5: Results at week 104**

	Wegovy	Placebo
Full analysis set (N)	152	152
<b>Body weight</b>		
Baseline (kg)	105.6	106.5
Change (%) from baseline <sup>1,2</sup>	-15.2	-2.6
Difference (%) from placebo <sup>1</sup> [95% CI]	-12.6 [-15.3; -9.8]*	-
Change (kg) from baseline	-16.1	-3.2
Difference (kg) from placebo <sup>1</sup> [95% CI]	-12.9 [-16.1; -9.8]	-
Patients (%) achieving weight loss $\geq 5\%$ <sup>3</sup>	74.7*	37.3
Patients (%) achieving weight loss $\geq 10\%$ <sup>3</sup>	59.2*	16.8
Patients (%) achieving weight loss $\geq 15\%$ <sup>3</sup>	49.7*	9.2
<b>Waist circumference (cm)</b>		
Baseline	115.8	115.7
Change from baseline <sup>1</sup>	-14.4	5.2
Difference from placebo <sup>1</sup> [95% CI]	-9.2 [-12.2; -6.2]*	-
<b>Systolic blood pressure (mmHg)</b>		
Baseline	126	125
Change from baseline <sup>1</sup>	-5.7	-1.6
Difference from placebo <sup>1</sup> [95% CI]	-4.2 [-7.3; -1.0]*	-

\* $p < 0.0001$  (unadjusted 2-sided) for superiority.

<sup>1</sup> Estimated using an ANCOVA model using multiple imputation based on all data irrespective of discontinuation of randomised treatment or initiation of other anti-obesity medication or bariatric surgery.

<sup>2</sup> During the trial, randomised treatment was permanently discontinued by 13.2% and 27.0% of patients randomised to semaglutide and placebo, respectively. Assuming that all randomised patients stayed on treatment and did not receive additional anti-obesity therapies, the estimated changes from randomisation to week 68 for body weight based on a Mixed Model for Repeated Measures including all observations until first discontinuation were -16.7% and -0.6% for semaglutide and placebo respectively.

<sup>3</sup> Estimated from binary regression model based on same imputation procedure as in primary analysis.

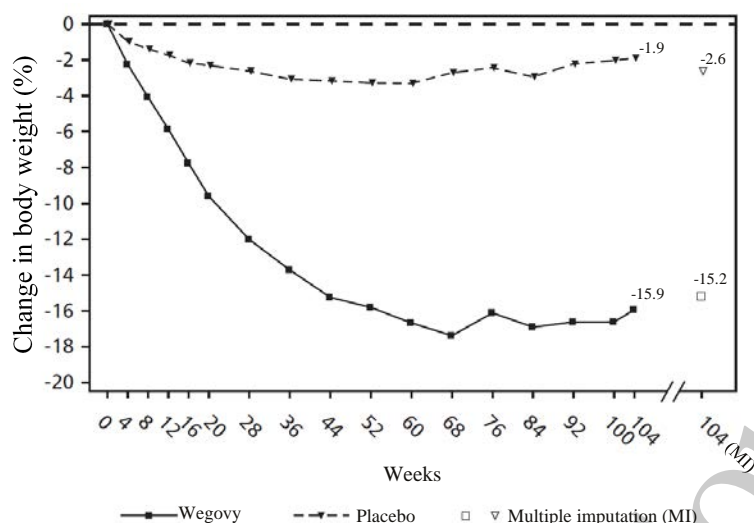

Observed values for patients completing each scheduled visit, and estimates with multiple imputations (MI) from retrieved dropouts

Figure 4 STEP 5: Mean change in body weight (%) from week 0 to week 104

### STEP 8: Semaglutide vs liraglutide

In a 68-week, randomised, open-label, pairwise placebo-controlled trial, 338 patients with obesity (BMI  $\geq 30$  kg/m<sup>2</sup>), or with overweight (BMI  $\geq 27$  to  $< 30$  kg/m<sup>2</sup>) and at least one weight-related comorbidity, were randomised to semaglutide once weekly, liraglutide 3 mg once daily or placebo. Semaglutide once weekly and liraglutide 3 mg were open-label, but each active treatment group was double-blinded against placebo administered at the same dosing frequency. All patients were on a reduced-calorie diet and increased physical activity throughout the trial. At baseline, patients had a mean BMI of 37.5 kg/m<sup>2</sup>, a mean body weight of 104.5 kg.

Treatment with semaglutide once weekly for 68 weeks resulted in superior and clinically meaningful reduction in body weight compared to liraglutide. Mean body weight decreased from baseline through to week 68 with semaglutide. With liraglutide, mean body weight decreased less (see Table 9). 37.4% of the patients treated with semaglutide lost  $\geq 20\%$ , compared to 7.0% treated with liraglutide. Table 9 shows the results of the confirmatory endpoints  $\geq 10\%$ ,  $\geq 15\%$  and  $\geq 20\%$  weight loss.

Table 9 STEP 8: Results of a 68-week trial comparing semaglutide with liraglutide

	Wegovy	Liraglutide 3 mg
Full analysis set (N)	126	127
<b>Body weight</b>		
Baseline (kg)	102.5	103.7
Change (%) from baseline <sup>1,2</sup>	-15.8	-6.4
Difference (%) from liraglutide <sup>1</sup> [95% CI]	-9.4 [-12.0;-6.8]*	-
Change (kg) from baseline	-15.3	-6.8
Difference (kg) from liraglutide <sup>1</sup> [95% CI]	-8.5 [-11.2;-5.7]	-
Patients (%) achieving weight loss $\geq 10\%$ <sup>3</sup>	69.4*	27.2
Patients (%) achieving weight loss $\geq 15\%$ <sup>3</sup>	54.0*	13.4
Patients (%) achieving weight loss $\geq 20\%$ <sup>3</sup>	37.4*	7.0

\* p<0.005 (unadjusted 2-sided) for superiority.

<sup>1</sup> Estimated using an ANCOVA model using multiple imputation based on all data irrespective of discontinuation of randomised treatment or initiation of other anti-obesity medication or bariatric surgery.

<sup>2</sup> During the trial, randomised treatment was permanently discontinued by 13.5% and 27.6% of patients randomised to semaglutide and

liraglutide, respectively. Assuming that all randomised patients stayed on treatment and did not receive additional anti-obesity therapies, the estimated changes from randomisation to week 68 for body weight based on a Mixed Model for Repeated Measures including all observations until first discontinuation were -16.7% and -6.7% for semaglutide and liraglutide respectively.

<sup>3</sup> Estimated from binary regression model based on same imputation procedure as in primary analysis.

### Effect on body composition

In a sub-study in STEP 1 (N = 140), body composition was measured using dual energy X-ray absorptiometry (DEXA). The results of the DEXA assessment showed that treatment with semaglutide was accompanied by greater reduction in fat mass than in lean body mass leading to an improvement in body composition compared to placebo after 68 weeks. Furthermore, this reduction in total fat mass was accompanied by a reduction in visceral fat. These results suggest that most of the total weight loss was attributable to a reduction in fat tissue, including visceral fat.

### Improvement in physical functioning

Semaglutide showed small improvements in physical functioning scores. Physical functioning was assessed using both the generic health-related quality of life questionnaire Short Form-36v2 Health Survey, Acute Version (SF-36) and the obesity-specific questionnaire Impact of Weight on Quality of Life Lite Clinical Trials Version (IWQOL-Lite-CT).

### Cardiovascular evaluation

In the SUSTAIN 6 trial, 3,297 patients with insufficiently controlled type 2 diabetes and at high risk of cardiovascular events were randomised to semaglutide s.c. 0.5 mg or 1 mg once-weekly or placebo in addition to standard-of-care. The treatment duration was 104 weeks. The mean age was 65 years and the mean BMI was 33 kg/m<sup>2</sup>.

The primary endpoint was the time from randomisation to first occurrence of a major adverse cardiovascular event (MACE): cardiovascular death, non-fatal myocardial infarction or non-fatal stroke. The total number of the MACE was 254, including 108 (6.6%) with semaglutide and 146 (8.9%) with placebo.

The cardiovascular safety of treatment with semaglutide 0.5 or 1 mg was confirmed as the hazard ratio (HR) for semaglutide vs. placebo was 0.74, [0.58, 0.95] [95% CI], driven by a decrease in the rate of non-fatal stroke and non-fatal myocardial infarction with no difference in cardiovascular death (see Figure 5).

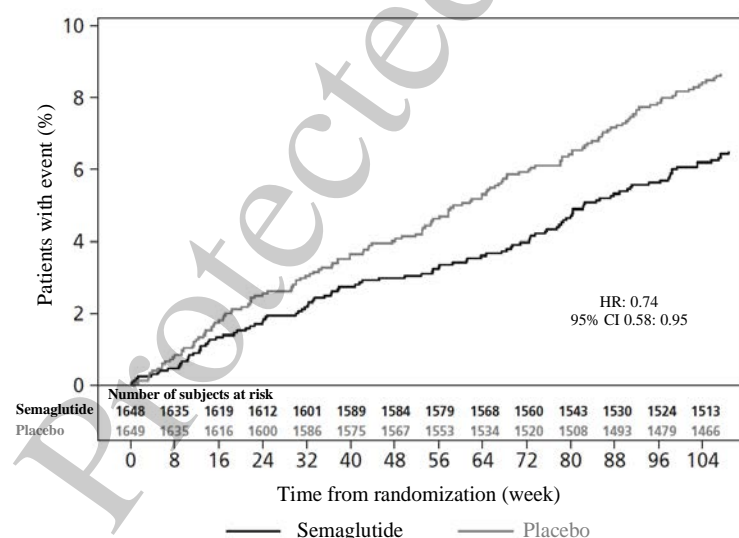

Figure 5: Kaplan-Meier plot of time to first occurrence of the composite outcome: Cardiovascular death, non-fatal myocardial infarction or non-fatal stroke (SUSTAIN 6)

## Paediatric population

The European Medicines Agency has deferred the obligation to submit the results of studies with Wegovy in one or more subsets of the paediatric population in the treatment of weight management (see section 4.2 for information on paediatric use).

### STEP TEENS: Weight management in adolescent patients

In a 68-week double-blind trial 201 pubertal adolescents, ages 12 to <18 years, with obesity or overweight and at least one weight-related comorbidity were randomised 2:1 to semaglutide or placebo. All patients were on a reduced-calorie diet and increased physical activity throughout the trial.

At end of treatment (week 68), the improvement in BMI with semaglutide was superior and clinically meaningful compared with placebo (see Table 10 and Figure 6). Furthermore, a higher proportion of patients achieved  $\geq 5\%$ ,  $10\%$  and  $\geq 15\%$  weight loss with semaglutide compared with placebo (see Table 10).

**Table 10 STEP TEENS: Results at week 68**

	Wegovy	Placebo
Full analysis set (N)	134	67
<b>BMI</b>		
Baseline (BMI)	37.7	35.7
Change (%) from baseline <sup>1,2</sup>	-16.1	0.6
Difference (%) from placebo <sup>1</sup> [95% CI]	-16.7 [-20.3; -13.2]*	-
Baseline (BMI SDS)	3.4	3.1
Change from baseline in BMI SDS <sup>1</sup>	-1.1	-0.1
Difference from placebo <sup>1</sup> [95% CI]	-1.0 [-1.3; -0.8]	-
<b>Body Weight</b>		
Baseline (kg)	109.9	102.6
Change (%) from baseline <sup>1</sup>	-14.7	2.8
Difference (%) from placebo <sup>1</sup> [95% CI]	-17.4 [-21.1; -13.8]	-
Change (kg) from baseline <sup>1</sup>	-15.3	2.4
Difference (kg) from placebo <sup>1</sup> [95% CI]	-17.7 [-21.8; -13.7]	-
Patients (%) achieving weight loss $\geq 5\%$ <sup>3</sup>	72.5*	17.7
Patients (%) achieving weight loss $\geq 10\%$ <sup>3</sup>	61.8	8.1
Patients (%) achieving weight loss $\geq 15\%$ <sup>3</sup>	53.4	4.8
<b>Waist circumference (cm)</b>		
Baseline	111.9	107.3
Change from baseline <sup>1</sup>	-12.7	-0.6
Difference from placebo <sup>1</sup> [95% CI]	-12.1 [-15.6; -8.7]	-
<b>Systolic blood pressure (mmHg)</b>		
Baseline	120	120
Change from baseline <sup>1</sup>	-2.7	-0.8
Difference from placebo <sup>1</sup> [95% CI]	-1.9 [-5.0; 1.1]	-

\*  $p < 0.0001$  (unadjusted 2-sided) for superiority.

<sup>1</sup> Estimated using an ANCOVA model using multiple imputation based on all data irrespective of discontinuation of randomised treatment or initiation of other anti-obesity medication or bariatric surgery.

<sup>2</sup> During the trial, randomised treatment was permanently discontinued by 10.4% and 10.4% of patients randomised to semaglutide 2.4 mg and placebo, respectively. Assuming that all randomised patients stayed on treatment and did not receive additional anti-obesity therapies, the estimated changes from randomisation to week 68 for BMI based on a Mixed Model for Repeated Measures including all observations until first discontinuation were -17.9% and 0.6% for semaglutide 2.4 mg and placebo respectively

<sup>3</sup> Estimated from logistic regression model based on same imputation procedure as in primary analysis.

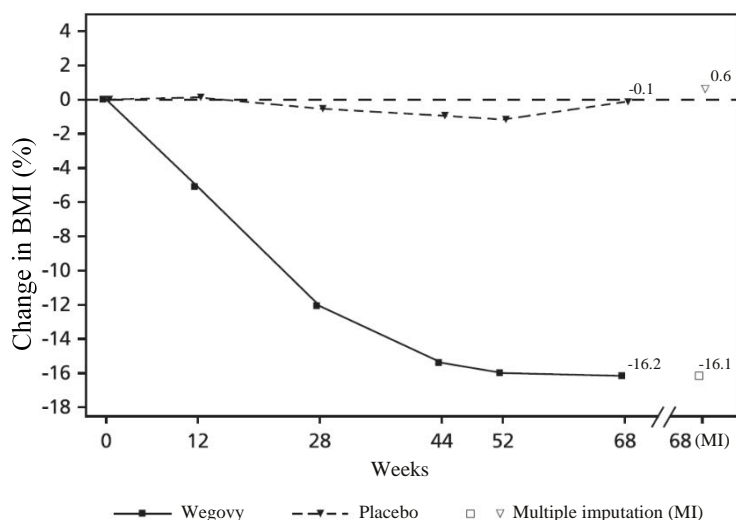

Observed values for patients completing each scheduled visit, and estimates with multiple imputations (MI) from retrieved dropouts

Figure 6 STEP TEENS: Mean change in BMI (%) from baseline to week 68

## 5.2 Pharmacokinetic properties

Compared to native GLP-1, semaglutide has a prolonged half-life of around 1 week making it suitable for once weekly subcutaneous administration. The principal mechanism of protraction is albumin binding, which results in decreased renal clearance and protection from metabolic degradation. Furthermore, semaglutide is stabilised against degradation by the DPP-4 enzyme.

### Absorption

The average semaglutide steady state concentration following s.c. administration of the semaglutide maintenance dose was approximately 75 nmol/L in patients with overweight (BMI  $\geq 27$  kg/m<sup>2</sup> to  $< 30$  kg/m<sup>2</sup>) or obesity (BMI  $\geq 30$  kg/m<sup>2</sup>) based on data from phase 3a trials, where 90% of patients had average concentrations between 51 nmol/L and 110 nmol/L. The steady state exposure of semaglutide increased proportionally with doses from 0.25 mg up to 2.4 mg once weekly. Steady state exposure was stable with time as assessed up to week 68. Similar exposure was achieved with s.c. administration of semaglutide in the abdomen, thigh, or upper arm. The absolute bioavailability of semaglutide was 89%.

### Distribution

The mean volume of distribution of semaglutide following s.c. administration in patients with overweight or obesity was approximately 12.4 L. Semaglutide is extensively bound to plasma albumin (>99%).

### Metabolism/biotransformation

Prior to excretion, semaglutide is extensively metabolised through proteolytic cleavage of the peptide backbone and sequential beta-oxidation of the fatty acid side chain. The enzyme neutral endopeptidase (NEP) was identified as one of the active metabolic enzymes.

### Elimination

The primary excretion routes of semaglutide-related material are via the urine and faeces. Approximately 3% of the absorbed dose was excreted in the urine as intact semaglutide. The clearance of semaglutide in patients with overweight (BMI  $\geq 27$  kg/m<sup>2</sup> to  $< 30$  kg/m<sup>2</sup>) or obesity (BMI  $\geq 30$  kg/m<sup>2</sup>) was approximately 0.05 L/h. With an elimination half-life of approximately 1 week, semaglutide will be present in the circulation for approximately 7 weeks after the last dose of 2.4 mg.

## Special populations

### Elderly

Age had no effect on the pharmacokinetics of semaglutide based on data from phase 3 trials including patients 18–86 years of age.

### Gender, race and ethnicity

Gender, race (White, Black or African American, Asian) and ethnicity (Hispanic or Latino, non-Hispanic or -Latino) had no effect on the pharmacokinetics of semaglutide based on data from phase 3a trials.

### Body weight

Body weight had an effect on the exposure of semaglutide. Higher body weight was associated with lower exposure; a 20% difference in body weight between individuals will result in an approximate 18% difference in exposure. The 2.4 mg weekly dose of semaglutide provided adequate systemic exposures over the body weight range of 54.4–245.6 kg evaluated for exposure response in the clinical trials.

### Renal impairment

Renal impairment did not impact the pharmacokinetics of semaglutide in a clinically relevant manner. This was shown with a single dose of 0.5 mg semaglutide for patients with different degrees of renal impairment (mild, moderate, severe or patients in dialysis) compared with patients with normal renal function. This was also shown for patients with overweight (BMI  $\geq 27$  kg/m<sup>2</sup> to  $< 30$  kg/m<sup>2</sup>) or obesity (BMI  $\geq 30$  kg/m<sup>2</sup>) and mild to moderate renal impairment based on data from phase 3a trials.

### Hepatic impairment

Hepatic impairment did not have any impact on the exposure of semaglutide. The pharmacokinetics of semaglutide were evaluated in patients with different degrees of hepatic impairment (mild, moderate, severe) and compared with patients with normal hepatic function in a study with a single dose of 0.5 mg semaglutide.

### Prediabetes and diabetes

Prediabetes and diabetes did not have any clinically relevant effect on the exposure of semaglutide based on data from phase 3 trials.

### Immunogenicity

Development of anti-semaglutide antibodies when treated with semaglutide occurred infrequently (see section 4.8) and the response did not appear to influence semaglutide pharmacokinetics.

### Paediatrics

Pharmacokinetic properties for semaglutide were assessed in a clinical trial for adolescent patients with obesity or overweight and at least one weight-related comorbidity ages 12 to  $< 18$  years (124 patients, body weight 61.6–211.9 kg). The semaglutide exposure in adolescents was similar to that in adults with obesity or overweight.

Safety and efficacy of semaglutide in children below 12 years of age have not been studied.

## **5.3 Preclinical safety data**

Preclinical data reveal no special hazards for humans based on conventional studies of safety pharmacology, repeat-dose toxicity or genotoxicity.

Non-lethal thyroid C-cell tumours observed in rodents are a class effect for GLP-1 receptor agonists. In 2-year carcinogenicity studies in rats and mice, semaglutide caused thyroid C-cell tumours at clinically relevant exposures. No other treatment-related tumours were observed. The rodent C-cell tumours are caused by a non-genotoxic, specific GLP-1 receptor mediated mechanism to which

rodents are particularly sensitive. The relevance for humans is considered to be low, but cannot be completely excluded.

In fertility studies in rats, semaglutide did not affect mating performance or male fertility. In female rats, an increase in oestrous cycle length and a small reduction in corpora lutea (ovulations) were observed at doses associated with maternal body weight loss.

In embryo-foetal development studies in rats, semaglutide caused embryotoxicity below clinically relevant exposures. Semaglutide caused marked reductions in maternal body weight and reductions in embryonic survival and growth. In foetuses, major skeletal and visceral malformations were observed, including effects on long bones, ribs, vertebrae, tail, blood vessels and brain ventricles. Mechanistic evaluations indicated that the embryotoxicity involved a GLP-1 receptor mediated impairment of the nutrient supply to the embryo across the rat yolk sac. Due to species differences in yolk sac anatomy and function, and due to lack of GLP-1 receptor expression in the yolk sac of non-human primates, this mechanism is considered unlikely to be of relevance to humans. However, a direct effect of semaglutide on the foetus cannot be excluded.

In developmental toxicity studies in rabbits and cynomolgus monkeys, increased pregnancy loss and slightly increased incidence of foetal abnormalities were observed at clinically relevant exposures. The findings coincided with marked maternal body weight loss of up to 16%. Whether these effects are related to the decreased maternal food consumption as a direct GLP-1 effect is unknown.

Postnatal growth and development were evaluated in cynomolgus monkeys. Infants were slightly smaller at delivery but recovered during the lactation period.

In juvenile rats, semaglutide caused delayed sexual maturation in both males and females. These delays had no impact upon fertility and reproductive capacity of either sex, or on the ability of the females to maintain pregnancy.

## **6. PHARMACEUTICAL PARTICULARS**

### **6.1 List of excipients**

#### Pre-filled pen, single-dose

Disodium phosphate, dihydrate  
Sodium chloride  
Hydrochloric acid (for pH adjustment)  
Sodium hydroxide (for pH adjustment)  
Water for injections

#### Pre-filled pen, FlexTouch

Disodium phosphate, dihydrate  
Propylene glycol  
Phenol  
Hydrochloric acid (for pH adjustment)  
Sodium hydroxide (for pH adjustment)  
Water for injection

### **6.2 Incompatibilities**

In the absence of compatibility studies this medicinal product must not be mixed with other medicinal products.

### 6.3 Shelf life

#### Pre-filled pen, single-dose

2 years.

Wegovy may be stored unrefrigerated for up to 28 days at a temperature not above 30°C. Discard the pen if it has been out of the refrigerator for more than 28 days.

#### Pre-filled pen, FlexTouch

Before use: 3 years.

After first use: 6 weeks. Store below 30°C or in a refrigerator (2°C to 8°C).

### 6.4 Special precautions for storage

Store in a refrigerator (2°C-8 °C). Keep away from the cooling element.  
Do not freeze.

#### Pre-filled pen, single-dose

Store the pen in the original carton in order to protect from light.

#### Pre-filled pen, FlexTouch

Keep the pen cap on when the pen is not in use in order to protect it from light.

### 6.5 Nature and contents of container

#### Pre-filled pen, single-dose

1 mL glass syringe (type I glass) with attached stainless steel needle, rigid needle shield (type II/polyisoprene) and a rubber plunger (type I/chlorobutyl).

#### Pre-filled pen, FlexTouch (0.25, 0.5 mg)

1.5 mL glass cartridge (type I glass) closed at the one end with a rubber plunger (chlorobutyl) and at the other end with an aluminium cap with a laminated rubber sheet (bromobutyl/polyisoprene) inserted. The cartridge is assembled into a disposable pre-filled pen made of polypropylene, polyoxymethylene, polycarbonate and acrylonitrile butadiene styrene.

#### Pre-filled pen, FlexTouch (1, 1.7 and 2.4 mg)

3 mL glass cartridge (type I glass) closed at the one end with a rubber plunger (chlorobutyl) and at the other end with an aluminium cap with a laminated rubber sheet (bromobutyl/polyisoprene) inserted. The cartridge is assembled into a disposable pre-filled pen made of polypropylene, polyoxymethylene, polycarbonate and acrylonitrile butadiene styrene.

#### Pack sizes

#### Pre-filled pen, single-dose (0.25, 0.5, 1, 1.7 and 2.4 mg)

Pack size of 4 pre-filled pens.

#### Pre-filled pen, FlexTouch (0.25, 0.5, 1 and 1.7 mg)

Pack size of 1 pre-filled pen and 4 disposable NovoFine Plus needles.



Pre-filled pen, FlexTouch (2.4 mg)

Pack sizes:

1 pre-filled pen and 4 disposable NovoFine Plus needles.

3 pre-filled pens and 12 disposable NovoFine Plus needles.

Not all pack sizes may be marketed.

## **6.6 Special precautions for disposal and other handling**

Wegovy should not be used if it does not appear clear and colourless.

The pen should not be used if it has been frozen.

Any unused medicinal product or waste material should be disposed of in accordance with local requirements.

Pre-filled pen, single-dose

The pen is for single-dose only.

Pre-filled pen, FlexTouch

This pen is for multi-use. It contains 4 doses.

The patient should be advised to discard the injection needle in accordance with local requirements after each injection and store the Wegovy pen without an injection needle attached. This may prevent blocked needles, contamination, infection, leakage of solution and inaccurate dosing.

The pen is for use by one person only.

Wegovy can be administered with 30G, 31G, and 32G disposable needles up to a length of 8 mm.

## **7. MARKETING AUTHORISATION HOLDER**

Novo Nordisk A/S  
Novo Allé  
DK-2880 Bagsværd  
Denmark

## **8. MARKETING AUTHORISATION NUMBERS**

EU/1/21/1608/001  
EU/1/21/1608/002  
EU/1/21/1608/003  
EU/1/21/1608/004  
EU/1/21/1608/005  
EU/1/21/1608/006  
EU/1/21/1608/007  
EU/1/21/1608/008  
EU/1/21/1608/009  
EU/1/21/1608/010  
EU/1/21/1608/011

**9. DATE OF FIRST AUTHORISATION/RENEWAL OF THE AUTHORISATION**

Date of first authorisation: 06 January 2022

**10. DATE OF REVISION OF THE TEXT**

Detailed information on this medicinal product is available on the website of the European Medicines Agency <http://www.ema.europa.eu>.

Protected by Copyright

**ANNEX II**

- A. MANUFACTURER OF THE BIOLOGICAL ACTIVE SUBSTANCE AND MANUFACTURER RESPONSIBLE FOR BATCH RELEASE**
- B. CONDITIONS OR RESTRICTIONS REGARDING SUPPLY AND USE**
- C. OTHER CONDITIONS AND REQUIREMENTS OF THE MARKETING AUTHORISATION**
- D. CONDITIONS OR RESTRICTIONS WITH REGARD TO THE SAFE AND EFFECTIVE USE OF THE MEDICINAL PRODUCT**

**A. MANUFACTURER OF THE BIOLOGICAL ACTIVE SUBSTANCE AND  
MANUFACTURER RESPONSIBLE FOR BATCH RELEASE**

Name and address of the manufacturer of the biological active substance

Novo Nordisk A/S  
Hallas Allé  
DK-4400 Kalundborg  
Denmark

Name and address of the manufacturer responsible for batch release

Novo Nordisk A/S  
Novo Allé  
DK-2880 Bagsværd  
Denmark

Novo Nordisk Production SAS  
45, Avenue d'Orléans  
28000 Chartres  
France

The printed package leaflet of the medicinal product must state the name and address of the manufacturer responsible for the release of the concerned batch.

**B. CONDITIONS OR RESTRICTIONS REGARDING SUPPLY AND USE**

Medicinal product subject to medical prescription.

**C. OTHER CONDITIONS AND REQUIREMENTS OF THE MARKETING  
AUTHORISATION**

• **Periodic safety update reports (PSURs)**

The requirements for submission of PSURs for this medicinal product are set out in the list of Union reference dates (EURD list) provided for under Article 107c(7) of Directive 2001/83/EC and any subsequent updates published on the European medicines web-portal.

The marketing authorisation holder (MAH) shall submit the first PSUR for this product within 6 months following authorisation.

**D. CONDITIONS OR RESTRICTIONS WITH REGARD TO THE SAFE AND  
EFFECTIVE USE OF THE MEDICINAL PRODUCT**

• **Risk management plan (RMP)**

The marketing authorisation holder (MAH) shall perform the required pharmacovigilance activities and interventions detailed in the agreed RMP presented in Module 1.8.2 of the marketing authorisation and any agreed subsequent updates of the RMP.

An updated RMP should be submitted:

- At the request of the European Medicines Agency;
- Whenever the risk management system is modified, especially as the result of new information being received that may lead to a significant change to the benefit/risk profile or as the result of an important (pharmacovigilance or risk minimisation) milestone being reached.

Protected by Copyright

**ANNEX III**

**LABELLING AND PACKAGE LEAFLET**

Protected by Copyright

**A. LABELLING**

Protected by Copyright

**PARTICULARS TO APPEAR ON THE OUTER PACKAGING**

**CARTON (single-dose)**

**1. NAME OF THE MEDICINAL PRODUCT**

Wegovy 0.25 mg solution for injection in pre-filled pen  
semaglutide

**2. STATEMENT OF ACTIVE SUBSTANCE**

Each pre-filled pen contains 0.25 mg semaglutide in 0.5 mL (0.5 mg/mL)

**3. LIST OF EXCIPIENTS**

Exipients: disodium phosphate dihydrate, sodium chloride, hydrochloric acid/sodium hydroxide (for pH adjustment), water for injections. See leaflet for further information

**4. PHARMACEUTICAL FORM AND CONTENTS**

Solution for injection  
4 pre-filled pens (1 pen delivers 1 dose)

**5. METHOD AND ROUTE OF ADMINISTRATION**

subcutaneous use  
once weekly

Read the package leaflet before use

For single use only

Push to open

**6. SPECIAL WARNING THAT THE MEDICINAL PRODUCT MUST BE STORED OUT OF THE SIGHT AND REACH OF CHILDREN**

Keep out of the sight and reach of children

**7. OTHER SPECIAL WARNINGS, IF NECESSARY**

**8. EXPIRY DATE**

EXP



**9. SPECIAL STORAGE CONDITIONS**

Store in a refrigerator. Do not freeze  
Keep the pen in the outer carton in order to protect from light  
Discard pen after use

**10. SPECIAL PRECAUTIONS FOR DISPOSAL OF UNUSED MEDICINAL PRODUCTS OR WASTE MATERIALS DERIVED FROM SUCH MEDICINAL PRODUCTS, IF APPROPRIATE**

**11. NAME AND ADDRESS OF THE MARKETING AUTHORISATION HOLDER**

Novo Nordisk A/S  
Novo Allé  
DK-2880 Bagsværd  
Denmark

**12. MARKETING AUTHORISATION NUMBER**

EU/1/21/1608/001

**13. BATCH NUMBER**

Batch

**14. GENERAL CLASSIFICATION FOR SUPPLY**

**15. INSTRUCTIONS ON USE**

**16. INFORMATION IN BRAILLE**

Wegovy 0.25 mg

**17. UNIQUE IDENTIFIER – 2D BARCODE**

2D barcode carrying the unique identifier included

**18. UNIQUE IDENTIFIER - HUMAN READABLE DATA**

PC  
SN  
NN

**MINIMUM PARTICULARS TO APPEAR ON SMALL IMMEDIATE PACKAGING UNITS**

**PRE-FILLED PEN LABEL (single-dose)**

**1. NAME OF THE MEDICINAL PRODUCT AND ROUTE OF ADMINISTRATION**

Wegovy 0.25 mg injection  
semaglutide  
SC

**2. METHOD OF ADMINISTRATION**

Subcutaneous use  
once weekly

**3. EXPIRY DATE**

EXP

**4. BATCH NUMBER**

Batch

**5. CONTENTS BY WEIGHT, BY VOLUME OR BY UNIT**

0.5 mL  
(1 dose)

**6. OTHER**

Novo Nordisk A/S

**PARTICULARS TO APPEAR ON THE OUTER PACKAGING**

**CARTON (single-dose)**

**1. NAME OF THE MEDICINAL PRODUCT**

Wegovy 0.5 mg solution for injection in pre-filled pen  
semaglutide

**2. STATEMENT OF ACTIVE SUBSTANCE**

Each pre-filled pen contains 0.5 mg semaglutide in 0.5 mL (1 mg/mL)

**3. LIST OF EXCIPIENTS**

Excipients: disodium phosphate dihydrate, sodium chloride, hydrochloric acid/sodium hydroxide (for pH adjustment), water for injections. See leaflet for further information

**4. PHARMACEUTICAL FORM AND CONTENTS**

Solution for injection  
4 pre-filled pens (1 pen delivers 1 dose)

**5. METHOD AND ROUTE OF ADMINISTRATION**

subcutaneous use  
once weekly

Read the package leaflet before use

For single use only

Push to open

**6. SPECIAL WARNING THAT THE MEDICINAL PRODUCT MUST BE STORED OUT OF THE SIGHT AND REACH OF CHILDREN**

Keep out of the sight and reach of children

**7. OTHER SPECIAL WARNINGS, IF NECESSARY**

**8. EXPIRY DATE**

EXP

**9. SPECIAL STORAGE CONDITIONS**

Store in a refrigerator. Do not freeze  
Keep the pen in the outer carton in order to protect from light  
Discard pen after use

**10. SPECIAL PRECAUTIONS FOR DISPOSAL OF UNUSED MEDICINAL PRODUCTS OR WASTE MATERIALS DERIVED FROM SUCH MEDICINAL PRODUCTS, IF APPROPRIATE**

**11. NAME AND ADDRESS OF THE MARKETING AUTHORISATION HOLDER**

Novo Nordisk A/S  
Novo Allé  
DK-2880 Bagsværd  
Denmark

**12. MARKETING AUTHORISATION NUMBER**

EU/1/21/1608/002

**13. BATCH NUMBER**

Batch

**14. GENERAL CLASSIFICATION FOR SUPPLY**

**15. INSTRUCTIONS ON USE**

**16. INFORMATION IN BRAILLE**

Wegovy 0.5 mg

**17. UNIQUE IDENTIFIER – 2D BARCODE**

2D barcode carrying the unique identifier included.

**18. UNIQUE IDENTIFIER - HUMAN READABLE DATA**

PC  
SN  
NN

**MINIMUM PARTICULARS TO APPEAR ON SMALL IMMEDIATE PACKAGING UNITS**

**PRE-FILLED PEN LABEL (single-dose)**

**1. NAME OF THE MEDICINAL PRODUCT AND ROUTE OF ADMINISTRATION**

Wegovy 0.5 mg injection  
semaglutide  
SC

**2. METHOD OF ADMINISTRATION**

Subcutaneous use  
once weekly

**3. EXPIRY DATE**

EXP

**4. BATCH NUMBER**

Batch

**5. CONTENTS BY WEIGHT, BY VOLUME OR BY UNIT**

0.5 mL  
(1 dose)

**6. OTHER**

Novo Nordisk A/S

**PARTICULARS TO APPEAR ON THE OUTER PACKAGING**

**CARTON (single-dose)**

**1. NAME OF THE MEDICINAL PRODUCT**

Wegovy 1 mg solution for injection in pre-filled pen  
semaglutide

**2. STATEMENT OF ACTIVE SUBSTANCE**

Each pre-filled pen contains 1 mg semaglutide in 0.5 mL (2 mg/mL)

**3. LIST OF EXCIPIENTS**

Excipients: disodium phosphate dihydrate, sodium chloride, hydrochloric acid/sodium hydroxide (for pH adjustment), water for injections. See leaflet for further information

**4. PHARMACEUTICAL FORM AND CONTENTS**

Solution for injection  
4 pre-filled pens (1 pen delivers 1 dose)

**5. METHOD AND ROUTE OF ADMINISTRATION**

subcutaneous use  
once weekly

Read the package leaflet before use

For single use only

Push to open

**6. SPECIAL WARNING THAT THE MEDICINAL PRODUCT MUST BE STORED OUT OF THE SIGHT AND REACH OF CHILDREN**

Keep out of the sight and reach of children

**7. OTHER SPECIAL WARNINGS, IF NECESSARY**

**8. EXPIRY DATE**

EXP

**9. SPECIAL STORAGE CONDITIONS**

Store in a refrigerator. Do not freeze  
Keep the pen in the outer carton in order to protect from light  
Discard pen after use

**10. SPECIAL PRECAUTIONS FOR DISPOSAL OF UNUSED MEDICINAL PRODUCTS OR WASTE MATERIALS DERIVED FROM SUCH MEDICINAL PRODUCTS, IF APPROPRIATE**

**11. NAME AND ADDRESS OF THE MARKETING AUTHORISATION HOLDER**

Novo Nordisk A/S  
Novo Allé  
DK-2880 Bagsværd  
Denmark

**12. MARKETING AUTHORISATION NUMBER**

EU/1/21/1608/003

**13. BATCH NUMBER**

Batch

**14. GENERAL CLASSIFICATION FOR SUPPLY**

**15. INSTRUCTIONS ON USE**

**16. INFORMATION IN BRAILLE**

Wegovy 1 mg

**17. UNIQUE IDENTIFIER – 2D BARCODE**

2D barcode carrying the unique identifier included.

**18. UNIQUE IDENTIFIER - HUMAN READABLE DATA**

PC  
SN  
NN

**MINIMUM PARTICULARS TO APPEAR ON SMALL IMMEDIATE PACKAGING UNITS**

**PRE-FILLED PEN LABEL (single-dose)**

**1. NAME OF THE MEDICINAL PRODUCT AND ROUTE OF ADMINISTRATION**

Wegovy 1 mg injection  
semaglutide  
SC

**2. METHOD OF ADMINISTRATION**

Subcutaneous use  
once weekly

**3. EXPIRY DATE**

EXP

**4. BATCH NUMBER**

Batch

**5. CONTENTS BY WEIGHT, BY VOLUME OR BY UNIT**

0.5 mL  
(1 dose)

**6. OTHER**

Novo Nordisk A/S



**PARTICULARS TO APPEAR ON THE OUTER PACKAGING**

**CARTON (single-dose)**

**1. NAME OF THE MEDICINAL PRODUCT**

Wegovy 1.7 mg solution for injection in pre-filled pen  
semaglutide

**2. STATEMENT OF ACTIVE SUBSTANCE**

Each pre-filled pen contains 1.7 mg semaglutide in 0.75 mL (2.27 mg/mL)

**3. LIST OF EXCIPIENTS**

Excipients: disodium phosphate dihydrate, sodium chloride, hydrochloric acid/sodium hydroxide (for pH adjustment), water for injections. See leaflet for further information

**4. PHARMACEUTICAL FORM AND CONTENTS**

Solution for injection  
4 pre-filled pens (1 pen delivers 1 dose)

**5. METHOD AND ROUTE OF ADMINISTRATION**

subcutaneous use  
once weekly

Read the package leaflet before use

For single use only

Push to open

**6. SPECIAL WARNING THAT THE MEDICINAL PRODUCT MUST BE STORED OUT OF THE SIGHT AND REACH OF CHILDREN**

Keep out of the sight and reach of children

**7. OTHER SPECIAL WARNINGS, IF NECESSARY**

**8. EXPIRY DATE**

EXP

**9. SPECIAL STORAGE CONDITIONS**

Store in a refrigerator. Do not freeze  
Keep the pen in the outer carton in order to protect from light  
Discard pen after use

**10. SPECIAL PRECAUTIONS FOR DISPOSAL OF UNUSED MEDICINAL PRODUCTS OR WASTE MATERIALS DERIVED FROM SUCH MEDICINAL PRODUCTS, IF APPROPRIATE**

**11. NAME AND ADDRESS OF THE MARKETING AUTHORISATION HOLDER**

Novo Nordisk A/S  
Novo Allé  
DK-2880 Bagsværd  
Denmark

**12. MARKETING AUTHORISATION NUMBER**

EU/1/21/1608/004

**13. BATCH NUMBER**

Batch

**14. GENERAL CLASSIFICATION FOR SUPPLY**

**15. INSTRUCTIONS ON USE**

**16. INFORMATION IN BRAILLE**

Wegovy 1.7 mg

**17. UNIQUE IDENTIFIER – 2D BARCODE**

2D barcode carrying the unique identifier included.

**18. UNIQUE IDENTIFIER - HUMAN READABLE DATA**

PC  
SN  
NN

**MINIMUM PARTICULARS TO APPEAR ON SMALL IMMEDIATE PACKAGING UNITS**

**PRE-FILLED PEN LABEL (single-dose)**

**1. NAME OF THE MEDICINAL PRODUCT AND ROUTE OF ADMINISTRATION**

Wegovy 1.7 mg injection  
semaglutide  
SC

**2. METHOD OF ADMINISTRATION**

Subcutaneous use  
once weekly

**3. EXPIRY DATE**

EXP

**4. BATCH NUMBER**

Batch

**5. CONTENTS BY WEIGHT, BY VOLUME OR BY UNIT**

0.75 mL  
(1 dose)

**6. OTHER**

Novo Nordisk A/S

**PARTICULARS TO APPEAR ON THE OUTER PACKAGING**

**CARTON (single-dose)**

**1. NAME OF THE MEDICINAL PRODUCT**

Wegovy 2.4 mg solution for injection in pre-filled pen  
semaglutide

**2. STATEMENT OF ACTIVE SUBSTANCE**

Each pre-filled pen contains 2.4 mg semaglutide in 0.75 mL (3.2 mg/mL)

**3. LIST OF EXCIPIENTS**

Excipients: disodium phosphate dihydrate, sodium chloride, hydrochloric acid/sodium hydroxide (for pH adjustment), water for injections. See leaflet for further information

**4. PHARMACEUTICAL FORM AND CONTENTS**

Solution for injection  
4 pre-filled pens (1 pen delivers 1 dose)

**5. METHOD AND ROUTE OF ADMINISTRATION**

subcutaneous use  
once weekly

Read the package leaflet before use

For single use only

Push to open

**6. SPECIAL WARNING THAT THE MEDICINAL PRODUCT MUST BE STORED OUT OF THE SIGHT AND REACH OF CHILDREN**

Keep out of the sight and reach of children

**7. OTHER SPECIAL WARNINGS, IF NECESSARY**

**8. EXPIRY DATE**

EXP

**9. SPECIAL STORAGE CONDITIONS**

Store in a refrigerator. Do not freeze  
Keep the pen in the outer carton in order to protect from light  
Discard pen after use

**10. SPECIAL PRECAUTIONS FOR DISPOSAL OF UNUSED MEDICINAL PRODUCTS OR WASTE MATERIALS DERIVED FROM SUCH MEDICINAL PRODUCTS, IF APPROPRIATE**

**11. NAME AND ADDRESS OF THE MARKETING AUTHORISATION HOLDER**

Novo Nordisk A/S  
Novo Allé  
DK-2880 Bagsværd  
Denmark

**12. MARKETING AUTHORISATION NUMBER**

EU/1/21/1608/005

**13. BATCH NUMBER**

Batch

**14. GENERAL CLASSIFICATION FOR SUPPLY**

**15. INSTRUCTIONS ON USE**

**16. INFORMATION IN BRAILLE**

Wegovy 2.4 mg

**17. UNIQUE IDENTIFIER – 2D BARCODE**

2D barcode carrying the unique identifier included.

**18. UNIQUE IDENTIFIER - HUMAN READABLE DATA**

PC  
SN  
NN

**MINIMUM PARTICULARS TO APPEAR ON SMALL IMMEDIATE PACKAGING UNITS**

**PRE-FILLED PEN LABEL (single-dose)**

**1. NAME OF THE MEDICINAL PRODUCT AND ROUTE OF ADMINISTRATION**

Wegovy 2.4 mg injection  
semaglutide  
SC

**2. METHOD OF ADMINISTRATION**

Subcutaneous use  
once weekly

**3. EXPIRY DATE**

EXP

**4. BATCH NUMBER**

Batch

**5. CONTENTS BY WEIGHT, BY VOLUME OR BY UNIT**

0.75 mL  
(1 dose)

**6. OTHER**

Novo Nordisk A/S

**PARTICULARS TO APPEAR ON THE OUTER PACKAGING**

**CARTON (multi-dose pre-filled pen (FlexTouch))**

**1. NAME OF THE MEDICINAL PRODUCT**

Wegovy 0.25 mg FlexTouch solution for injection in pre-filled pen  
semaglutide

**2. STATEMENT OF ACTIVE SUBSTANCE**

Each pre-filled pen contains 1 mg semaglutide in 1.5 mL (0.68 mg/mL)

**3. LIST OF EXCIPIENTS**

Excipients: disodium phosphate dihydrate, propylene glycol, phenol, hydrochloric acid/sodium hydroxide (for pH adjustment), water for injections. See leaflet for further information

**4. PHARMACEUTICAL FORM AND CONTENTS**

solution for injection

1 pen and 4 disposable needles (1 pen = 4 doses)

**5. METHOD AND ROUTE OF ADMINISTRATION**

subcutaneous use  
once weekly

Read the package leaflet before use

Use Wegovy once a week

Write the weekday you choose to inject

I injected my weekly dose on the below dates

<input type="text"/>	<input type="text"/>	<input type="text"/>	<input type="text"/>
----------------------	----------------------	----------------------	----------------------

Open here

Lift here

**6. SPECIAL WARNING THAT THE MEDICINAL PRODUCT MUST BE STORED OUT OF THE SIGHT AND REACH OF CHILDREN**

Keep out of the sight and reach of children.

**7. OTHER SPECIAL WARNINGS, IF NECESSARY**

Do not store the pen with a needle attached.  
For use by one person only.

**8. EXPIRY DATE**

EXP

**9. SPECIAL STORAGE CONDITIONS**

Store in a refrigerator. Do not freeze.  
After the first use of the pen, store below 30°C. Do not freeze.  
Keep the pen cap on in order to protect from light.  
Discard pen 6 weeks after first use.

**10. SPECIAL PRECAUTIONS FOR DISPOSAL OF UNUSED MEDICINAL PRODUCTS OR WASTE MATERIALS DERIVED FROM SUCH MEDICINAL PRODUCTS, IF APPROPRIATE**

**11. NAME AND ADDRESS OF THE MARKETING AUTHORISATION HOLDER**

Novo Nordisk A/S  
Novo Allé  
DK-2880 Bagsværd  
Denmark

**12. MARKETING AUTHORISATION NUMBERS**

EU/1/21/1608/006

**13. BATCH NUMBER**

Batch

**14. GENERAL CLASSIFICATION FOR SUPPLY**

**15. INSTRUCTIONS ON USE**

**16. INFORMATION IN BRAILLE**

Wegovy 0.25 mg FlexTouch



**17. UNIQUE IDENTIFIER – 2D BARCODE**

2D barcode carrying the unique identifier included.

**18. UNIQUE IDENTIFIER - HUMAN READABLE DATA**

PC  
SN  
NN

Protected by Copyright

**MINIMUM PARTICULARS TO APPEAR ON SMALL IMMEDIATE PACKAGING UNITS**

**PRE-FILLED PEN LABEL (multi-dose pre-filled pen (FlexTouch))**

**1. NAME OF THE MEDICINAL PRODUCT AND ROUTE OF ADMINISTRATION**

Wegovy 0.25 mg injection  
FlexTouch  
semaglutide  
SC

**2. METHOD OF ADMINISTRATION**

Subcutaneous use  
once weekly

**3. EXPIRY DATE**

EXP

**4. BATCH NUMBER**

Batch

**5. CONTENTS BY WEIGHT, BY VOLUME OR BY UNIT**

1.5 mL  
(4 doses)

**6. OTHER**

Novo Nordisk A/S

**PARTICULARS TO APPEAR ON THE OUTER PACKAGING**

**CARTON (multi-dose pre-filled pen (FlexTouch))**

**1. NAME OF THE MEDICINAL PRODUCT**

Wegovy 0.5 mg FlexTouch solution for injection in pre-filled pen  
semaglutide

**2. STATEMENT OF ACTIVE SUBSTANCE**

Each pre-filled pen contains 2 mg semaglutide in 1.5 mL (1.34 mg/mL)

**3. LIST OF EXCIPIENTS**

Excipients: disodium phosphate dihydrate, propylene glycol, phenol, hydrochloric acid/sodium hydroxide (for pH adjustment), water for injections. See leaflet for further information

**4. PHARMACEUTICAL FORM AND CONTENTS**

solution for injection

1 pen and 4 disposable needles (1 pen = 4 doses)

**5. METHOD AND ROUTE OF ADMINISTRATION**

subcutaneous use  
once weekly

Read the package leaflet before use

Use Wegovy once a week

Write the weekday you choose to inject

I injected my weekly dose on the below dates

<input type="text"/>	<input type="text"/>	<input type="text"/>	<input type="text"/>
----------------------	----------------------	----------------------	----------------------

Open here

Lift here

**6. SPECIAL WARNING THAT THE MEDICINAL PRODUCT MUST BE STORED OUT OF THE SIGHT AND REACH OF CHILDREN**

Keep out of the sight and reach of children.

**7. OTHER SPECIAL WARNINGS, IF NECESSARY**

Do not store the pen with a needle attached.  
For use by one person only.

**8. EXPIRY DATE**

EXP

**9. SPECIAL STORAGE CONDITIONS**

Store in a refrigerator. Do not freeze.  
After the first use of the pen, store below 30°C. Do not freeze.  
Keep the pen cap on in order to protect from light.  
Discard pen 6 weeks after first use.

**10. SPECIAL PRECAUTIONS FOR DISPOSAL OF UNUSED MEDICINAL PRODUCTS OR WASTE MATERIALS DERIVED FROM SUCH MEDICINAL PRODUCTS, IF APPROPRIATE**

**11. NAME AND ADDRESS OF THE MARKETING AUTHORISATION HOLDER**

Novo Nordisk A/S  
Novo Allé  
DK-2880 Bagsværd  
Denmark

**12. MARKETING AUTHORISATION NUMBERS**

EU/1/21/1608/007

**13. BATCH NUMBER**

Batch

**14. GENERAL CLASSIFICATION FOR SUPPLY**

**15. INSTRUCTIONS ON USE**

**16. INFORMATION IN BRAILLE**

Wegovy 0.5 mg FlexTouch

**17. UNIQUE IDENTIFIER – 2D BARCODE**

2D barcode carrying the unique identifier included.

**18. UNIQUE IDENTIFIER - HUMAN READABLE DATA**

PC  
SN  
NN

Protected by Copyright

**MINIMUM PARTICULARS TO APPEAR ON SMALL IMMEDIATE PACKAGING UNITS**

**PRE-FILLED PEN LABEL (multi-dose pre-filled pen (FlexTouch))**

**1. NAME OF THE MEDICINAL PRODUCT AND ROUTE OF ADMINISTRATION**

Wegovy 0.5 mg injection  
FlexTouch  
semaglutide  
SC

**2. METHOD OF ADMINISTRATION**

Subcutaneous use  
once weekly

**3. EXPIRY DATE**

EXP

**4. BATCH NUMBER**

Batch

**5. CONTENTS BY WEIGHT, BY VOLUME OR BY UNIT**

1.5 mL  
(4 doses)

**6. OTHER**

Novo Nordisk A/S

**PARTICULARS TO APPEAR ON THE OUTER PACKAGING**

**CARTON (multi-dose pre-filled pen (FlexTouch))**

**1. NAME OF THE MEDICINAL PRODUCT**

Wegovy 1 mg FlexTouch solution for injection in pre-filled pen  
semaglutide

**2. STATEMENT OF ACTIVE SUBSTANCE**

Each pre-filled pen contains 4 mg semaglutide in 3 mL (1.34 mg/mL)

**3. LIST OF EXCIPIENTS**

Excipients: disodium phosphate dihydrate, propylene glycol, phenol, hydrochloric acid/sodium hydroxide (for pH adjustment), water for injections. See leaflet for further information

**4. PHARMACEUTICAL FORM AND CONTENTS**

solution for injection

1 pen and 4 disposable needles (1 pen = 4 doses)

**5. METHOD AND ROUTE OF ADMINISTRATION**

subcutaneous use  
once weekly

Read the package leaflet before use

Use Wegovy once a week

Write the weekday you choose to inject

I injected my weekly dose on the below dates

Open here

Lift here

**6. SPECIAL WARNING THAT THE MEDICINAL PRODUCT MUST BE STORED OUT OF THE SIGHT AND REACH OF CHILDREN**

Keep out of the sight and reach of children.

**7. OTHER SPECIAL WARNINGS, IF NECESSARY**

Do not store the pen with a needle attached.  
For use by one person only.

**8. EXPIRY DATE**

EXP

**9. SPECIAL STORAGE CONDITIONS**

Store in a refrigerator. Do not freeze.  
After the first use of the pen, store below 30°C. Do not freeze.  
Keep the pen cap on in order to protect from light.  
Discard pen 6 weeks after first use.

**10. SPECIAL PRECAUTIONS FOR DISPOSAL OF UNUSED MEDICINAL PRODUCTS OR WASTE MATERIALS DERIVED FROM SUCH MEDICINAL PRODUCTS, IF APPROPRIATE**

**11. NAME AND ADDRESS OF THE MARKETING AUTHORISATION HOLDER**

Novo Nordisk A/S  
Novo Allé  
DK-2880 Bagsværd  
Denmark

**12. MARKETING AUTHORISATION NUMBERS**

EU/1/21/1608/008

**13. BATCH NUMBER**

Batch

**14. GENERAL CLASSIFICATION FOR SUPPLY**

**15. INSTRUCTIONS ON USE**

**16. INFORMATION IN BRAILLE**

Wegovy 1 mg FlexTouch



**17. UNIQUE IDENTIFIER – 2D BARCODE**

2D barcode carrying the unique identifier included.

**18. UNIQUE IDENTIFIER - HUMAN READABLE DATA**

PC  
SN  
NN

Protected by Copyright

**MINIMUM PARTICULARS TO APPEAR ON SMALL IMMEDIATE PACKAGING UNITS**

**PRE-FILLED PEN LABEL (multi-dose pre-filled pen (FlexTouch))**

**1. NAME OF THE MEDICINAL PRODUCT AND ROUTE OF ADMINISTRATION**

Wegovy 1 mg injection  
FlexTouch  
semaglutide  
SC

**2. METHOD OF ADMINISTRATION**

Subcutaneous use  
once weekly

**3. EXPIRY DATE**

EXP

**4. BATCH NUMBER**

Batch

**5. CONTENTS BY WEIGHT, BY VOLUME OR BY UNIT**

3 mL  
(4 doses)

**6. OTHER**

Novo Nordisk A/S

**PARTICULARS TO APPEAR ON THE OUTER PACKAGING**

**CARTON (multi-dose pre-filled pen (FlexTouch))**

**1. NAME OF THE MEDICINAL PRODUCT**

Wegovy 1.7 mg FlexTouch solution for injection in pre-filled pen  
semaglutide

**2. STATEMENT OF ACTIVE SUBSTANCE**

Each pre-filled pen contains 6.8 mg semaglutide in 3 mL (2.27 mg/mL)

**3. LIST OF EXCIPIENTS**

Excipients: disodium phosphate dihydrate, propylene glycol, phenol, hydrochloric acid/sodium hydroxide (for pH adjustment), water for injections. See leaflet for further information

**4. PHARMACEUTICAL FORM AND CONTENTS**

solution for injection

1 pen and 4 disposable needles (1 pen = 4 doses)

**5. METHOD AND ROUTE OF ADMINISTRATION**

subcutaneous use  
once weekly

Read the package leaflet before use

Use Wegovy once a week

Write the weekday you choose to inject

I injected my weekly dose on the below dates

Open here

Lift here

**6. SPECIAL WARNING THAT THE MEDICINAL PRODUCT MUST BE STORED OUT OF THE SIGHT AND REACH OF CHILDREN**

Keep out of the sight and reach of children.

**7. OTHER SPECIAL WARNINGS, IF NECESSARY**

Do not store the pen with a needle attached.  
For use by one person only.

**8. EXPIRY DATE**

EXP

**9. SPECIAL STORAGE CONDITIONS**

Store in a refrigerator. Do not freeze.  
After the first use of the pen, store below 30°C. Do not freeze.  
Keep the pen cap on in order to protect from light.  
Discard pen 6 weeks after first use.

**10. SPECIAL PRECAUTIONS FOR DISPOSAL OF UNUSED MEDICINAL PRODUCTS OR WASTE MATERIALS DERIVED FROM SUCH MEDICINAL PRODUCTS, IF APPROPRIATE**

**11. NAME AND ADDRESS OF THE MARKETING AUTHORISATION HOLDER**

Novo Nordisk A/S  
Novo Allé  
DK-2880 Bagsværd  
Denmark

**12. MARKETING AUTHORISATION NUMBERS**

EU/1/21/1608/009

**13. BATCH NUMBER**

Batch

**14. GENERAL CLASSIFICATION FOR SUPPLY**

**15. INSTRUCTIONS ON USE**

**16. INFORMATION IN BRAILLE**

Wegovy 1.7 mg FlexTouch

**17. UNIQUE IDENTIFIER – 2D BARCODE**

2D barcode carrying the unique identifier included.

**18. UNIQUE IDENTIFIER - HUMAN READABLE DATA**

PC  
SN  
NN

Protected by Copyright

**MINIMUM PARTICULARS TO APPEAR ON SMALL IMMEDIATE PACKAGING UNITS**

**PRE-FILLED PEN LABEL (multi-dose pre-filled pen (FlexTouch))**

**1. NAME OF THE MEDICINAL PRODUCT AND ROUTE OF ADMINISTRATION**

Wegovy 1.7 mg injection  
FlexTouch  
semaglutide  
SC

**2. METHOD OF ADMINISTRATION**

Subcutaneous use  
once weekly

**3. EXPIRY DATE**

EXP

**4. BATCH NUMBER**

Batch

**5. CONTENTS BY WEIGHT, BY VOLUME OR BY UNIT**

3 mL  
(4 doses)

**6. OTHER**

Novo Nordisk A/S

**PARTICULARS TO APPEAR ON THE OUTER PACKAGING**

**CARTON (multi-dose pre-filled pen (FlexTouch))**

**1. NAME OF THE MEDICINAL PRODUCT**

Wegovy 2.4 mg FlexTouch solution for injection in pre-filled pen  
semaglutide

**2. STATEMENT OF ACTIVE SUBSTANCE**

Each pre-filled pen contains 9.6 mg semaglutide in 3 mL (3.2 mg/mL)

**3. LIST OF EXCIPIENTS**

Excipients: disodium phosphate dihydrate, propylene glycol, phenol, hydrochloric acid/sodium hydroxide (for pH adjustment), water for injections. See leaflet for further information

**4. PHARMACEUTICAL FORM AND CONTENTS**

solution for injection

1 pen and 4 disposable needles (1 pen = 4 doses)

3 pens and 12 disposable needles (1 pen = 4 doses)

**5. METHOD AND ROUTE OF ADMINISTRATION**

subcutaneous use  
once weekly

Read the package leaflet before use

Use Wegovy once a week

Write the weekday you choose to inject

I injected my weekly dose on the below dates

--	--	--	--

--	--	--	--

--	--	--	--

Open here

Lift here

**6. SPECIAL WARNING THAT THE MEDICINAL PRODUCT MUST BE STORED OUT OF THE SIGHT AND REACH OF CHILDREN**

Keep out of the sight and reach of children.

**7. OTHER SPECIAL WARNINGS, IF NECESSARY**

Do not store the pen with a needle attached.  
For use by one person only.

**8. EXPIRY DATE**

EXP

**9. SPECIAL STORAGE CONDITIONS**

Store in a refrigerator. Do not freeze.  
After the first use of the pen, store below 30°C. Do not freeze.  
Keep the pen cap on in order to protect from light.  
Discard pen 6 weeks after first use.

**10. SPECIAL PRECAUTIONS FOR DISPOSAL OF UNUSED MEDICINAL PRODUCTS OR WASTE MATERIALS DERIVED FROM SUCH MEDICINAL PRODUCTS, IF APPROPRIATE**

**11. NAME AND ADDRESS OF THE MARKETING AUTHORISATION HOLDER**

Novo Nordisk A/S  
Novo Allé  
DK-2880 Bagsværd  
Denmark

**12. MARKETING AUTHORISATION NUMBERS**

EU/1/21/1608/010 1 pen and 4 disposable needles  
EU/1/21/1608/011 3 pens and 12 disposable needles

**13. BATCH NUMBER**

Batch

**14. GENERAL CLASSIFICATION FOR SUPPLY**



**15. INSTRUCTIONS ON USE**

**16. INFORMATION IN BRAILLE**

Wegovy 2.4 mg FlexTouch

**17. UNIQUE IDENTIFIER – 2D BARCODE**

2D barcode carrying the unique identifier included.

**18. UNIQUE IDENTIFIER - HUMAN READABLE DATA**

PC  
SN  
NN

Protected by Copyright

**MINIMUM PARTICULARS TO APPEAR ON SMALL IMMEDIATE PACKAGING UNITS**

**PRE-FILLED PEN LABEL (multi-dose pre-filled pen (FlexTouch))**

**1. NAME OF THE MEDICINAL PRODUCT AND ROUTE OF ADMINISTRATION**

Wegovy 2.4 mg injection  
FlexTouch  
semaglutide  
SC

**2. METHOD OF ADMINISTRATION**

Subcutaneous use  
once weekly

**3. EXPIRY DATE**

EXP

**4. BATCH NUMBER**

Batch

**5. CONTENTS BY WEIGHT, BY VOLUME OR BY UNIT**

3 mL  
(4 doses)

**6. OTHER**

Novo Nordisk A/S

Protected by Copyright

**B. PACKAGE LEAFLET**

### Package leaflet: Information for the patient

**Wegovy 0.25 mg solution for injection in pre-filled pen**  
**Wegovy 0.5 mg solution for injection in pre-filled pen**  
**Wegovy 1 mg solution for injection in pre-filled pen**  
**Wegovy 1.7 mg solution for injection in pre-filled pen**  
**Wegovy 2.4 mg solution for injection in pre-filled pen**  
semaglutide

▼ This medicine is subject to additional monitoring. This will allow quick identification of new safety information. You can help by reporting any side effects you may get. See the end of section 4 for how to report side effects.

#### **Read all of this leaflet carefully before you start using this medicine because it contains important information for you.**

- Keep this leaflet. You may need to read it again.
- If you have any further questions, ask your doctor, pharmacist or nurse.
- This medicine has been prescribed for you only. Do not pass it on to others. It may harm them, even if their signs of illness are the same as yours.
- If you get any side effects, talk to your doctor, pharmacist or nurse. This includes any possible side effects not listed in this leaflet. See section 4.

#### **What is in this leaflet**

1. What Wegovy is and what it is used for
2. What you need to know before you use Wegovy
3. How to use Wegovy
4. Possible side effects
5. How to store Wegovy
6. Contents of the pack and other information

### **1. What Wegovy is and what it is used for**

#### **What Wegovy is**

Wegovy is a medicine for weight loss and weight maintenance that contains the active substance semaglutide. It is similar to a natural hormone called glucagon-like peptide-1 (GLP-1) that is released from the intestine after a meal. It works by acting on targets (receptors) in the brain that control your appetite, causing you to feel fuller and less hungry and experience less craving for food. This will help you eat less food and reduce your body weight.

#### **What Wegovy is used for**

Wegovy is used together with diet and physical activity for weight loss and to help keep the weight under control. It is used in adults, who have

- a BMI of 30 kg/m<sup>2</sup> or greater (obesity) or
- a BMI of at least 27 kg/m<sup>2</sup> but less than 30 kg/m<sup>2</sup> (overweight) who have weight-related health problems (such as diabetes, high blood pressure, abnormal levels of fats in the blood, breathing problems during sleep called 'obstructive sleep apnoea' or a history of heart attack, stroke or blood vessel problems).

BMI (Body Mass Index) is a measure of your weight in relation to your height.

Wegovy is used together with diet and physical activity for weight management in adolescents ages 12 years and above, who have

- obesity and
- body weight >60 kg.

As an adolescent patient, you should only continue using Wegovy if you have lost at least 5% of your BMI after 12 weeks on the 2.4 mg dose or maximum tolerated dose (see section 3). Consult your doctor before you continue.

## 2. What you need to know before you use Wegovy

### Do not use Wegovy

- if you are allergic to semaglutide or any of the other ingredients of this medicine (listed in section 6).

### Warnings and precautions

Talk to your doctor, pharmacist or nurse before using Wegovy.

The use of Wegovy is not recommended if you:

- use other products for weight loss,
- have type 1 diabetes,
- have severely reduced kidney function,
- have severely reduced liver function,
- have severe heart failure,
- have diabetic eye disease (retinopathy).

There is little experience with Wegovy in patients:

- of 75 years and older,
- with liver problems,
- with severe stomach or gut problem which results in delayed stomach emptying (called gastroparesis), or if you have an inflammatory bowel disease.

Please consult your doctor if one of the above applies to you.

- **Dehydration**

During treatment with Wegovy, you may feel sick (nausea) or be sick (vomiting), or have diarrhoea. These side effects can cause dehydration (loss of fluids). It is important that you drink enough fluids to prevent dehydration. This is especially important if you have kidney problems. Talk to your doctor if you have any questions or concerns.

- **Inflammation of the pancreas**

If you have severe and on-going pain in the stomach area (see section 4) – see a doctor straight away as this could be a sign of inflamed pancreas (acute pancreatitis).

- **People with type 2 diabetes**

Wegovy cannot be used as a substitute for insulin. Do not use Wegovy in combination with other medicines that contain GLP-1 receptor agonists (such as liraglutide, dulaglutide, exenatide or lixisenatide).

- **Low blood sugar (hypoglycaemia)**

Taking a sulfonylurea or an insulin with Wegovy might increase the risk of getting low blood sugar levels (hypoglycaemia). Please see section 4 for the warning signs of low blood sugar levels. Your doctor may ask you to test your blood sugar levels. This will help your doctor decide if the dose of the sulfonylurea or insulin needs to be changed to reduce the risk of low blood sugar.

- **Diabetic eye disease (retinopathy)**

If you have diabetic eye disease and are using insulin, this medicine may lead to a worsening of your vision, and this may require treatment. Fast improvements in blood sugar control may lead to a temporary worsening of diabetic eye disease. If you have diabetic eye disease and experience eye problems while taking this medicine, talk to your doctor.

### **Children and adolescents**

The safety and efficacy of Wegovy in children below 12 years of age have not been studied and are not recommended for use in this population.

### **Other medicines and Wegovy**

Tell your doctor, pharmacist or nurse if you are using, have recently used or might use any other medicines.

In particular, tell your doctor, pharmacist or nurse if you are using medicines containing the following:

- Warfarin or other similar medicines taken by mouth to reduce blood clotting (oral anti-coagulants). When you start treatment with e.g. warfarin or similar medicines, frequent blood testing to determine the ability of your blood to clot may be required.

### **Pregnancy and breast-feeding**

This medicine should not be used during pregnancy, as it is not known if it may affect your unborn child. Therefore, it is recommended to use contraception while using this medicine. If you wish to become pregnant, you should stop using this medicine at least two months in advance. If you become or are pregnant, think you may be pregnant or are planning to have a baby when using this medicine, talk to your doctor straight away, as your treatment will need to be stopped.

Do not use this medicine if you are breast-feeding, as it is unknown if it passes into breast milk.

### **Driving and using machines**

Wegovy is unlikely to affect your ability to drive and use machines. Some patients may feel dizzy when taking Wegovy mainly during the first 4 months of treatment (see section 4). If you feel dizzy be extra careful while driving or using machines. If you need any further information, talk to your doctor, pharmacist or nurse.

#### *People with type 2 diabetes*

If you use this medicine in combination with a sulfonylurea or insulin, low blood sugar (hypoglycaemia) may occur which may reduce your ability to concentrate. Avoid driving or using machines if you get any signs of low blood sugar. See section 2, 'Warnings and precautions' for information on increased risk of low blood sugar and section 4 for the warning signs of low blood sugar. Talk to your doctor for further information.

### **Wegovy contains sodium**

This medicine contains less than 1 mmol sodium (23 mg) per dose, that is to say essentially 'sodium-free'.

## **3. How to use Wegovy**

Always use this medicine exactly as your doctor has told you. Check with your doctor, pharmacist or nurse if you are not sure.

### **How much to use**

#### *Adults*

The recommended dose is 2.4 mg once weekly.

Your treatment will start at a low dose which will be gradually increased over 16 weeks of treatment.

- When you first start using Wegovy, the starting dose is 0.25 mg once weekly.
- Your doctor will instruct you to gradually increase your dose every 4 weeks until you reach the recommended dose of 2.4 mg once weekly.
- Once you reach the recommended dose of 2.4 mg, do not increase this dose further.
- In case you are feeling very bothered by sickness (nausea) or by being sick (vomiting) talk with your doctor about delaying dose escalation or lowering to the previous dose until symptoms have improved.

Usually, you will be told to follow the table below.

Dose escalation	Weekly dose
Week 1–4	0.25 mg
Week 5–8	0.5 mg
Week 9–12	1 mg
Week 13–16	1.7 mg
From week 17	2.4 mg

Your doctor will assess your treatment on a regular basis.

#### *Adolescents (above 12 years of age)*

For adolescents, the same dose escalation schedule as for adults should be applied (see above). The dose should be increased until 2.4 mg (maintenance dose) or maximum tolerated dose has been reached. Weekly doses higher than 2.4 mg are not recommended.

#### **How Wegovy is given**

Wegovy is given as an injection under the skin (subcutaneous injection). Do not inject it into a vein or muscle.

- The best places to give the injection are the front of your upper arm, upper legs or stomach.
- Before you use the pen for the first time, your doctor, pharmacist or nurse will show you how to use it.

Detailed instructions on how to use the pen are on the other side of this leaflet.

#### **People with type 2 diabetes**

Tell your doctor if you have type 2 diabetes. Your doctor may adjust the dose of your diabetes medicines to prevent you from getting low blood sugar.

#### **When to use Wegovy**

- You should use this medicine once a week and if possible, on the same day each week.
- You can give yourself the injection at any time of the day – regardless of meals.

If necessary, you can change the day of your weekly injection of this medicine as long as it has been at least 3 days since your last injection. After selecting a new dosing day, continue with once a week dosing.

#### **If you use more Wegovy than you should**

Talk to your doctor straight away. You may get side effects such as feeling sick (nausea), being sick (vomiting) or have diarrhoea, which may cause dehydration (loss of fluids).

#### **If you forget to use Wegovy**

If you forgot to inject a dose and:

- it is 5 days or less since you should have used Wegovy, use it as soon as you remember. Then inject your next dose as usual on your scheduled day.
- it is more than 5 days since you should have used Wegovy, skip the missed dose. Then inject your next dose as usual on your next scheduled day.

Do not use a double dose to make up for a forgotten dose.

#### **If you stop using Wegovy**

Do not stop using this medicine without talking to your doctor.

If you have any further questions on the use of this medicine, ask your doctor, pharmacist or nurse.

#### 4. Possible side effects

Like all medicines, this medicine can cause side effects, although not everybody gets them.

##### Serious side effects

**Common** (may affect up to 1 in 10 people)

- Complications of diabetic eye disease (diabetic retinopathy). If you have diabetes you should inform your doctor if you experience eye problems, such as changes in vision, during treatment with this medicine.

**Uncommon** (may affect up to 1 in 100 people)

- Inflamed pancreas (acute pancreatitis). Signs of inflamed pancreas may include severe and long-lasting pain in your stomach, the pain may move to your back. You should see your doctor immediately if you experience such symptoms.

**Rare** (may affect up to 1 in 1,000 people)

- Severe allergic reactions (anaphylactic reactions, angioedema). You should seek immediate medical help and inform your doctor straight away if you get symptoms such as breathing difficulty, swelling, light-headedness, fast heartbeat, sweating and loss of consciousness or rapid swelling under the skin in areas such as the face, throat, arms and legs, which can be life threatening if throat swelling blocks the airway.

##### Other side effects

**Very common** (may affect more than 1 in 10 people)

- headache
  - feeling sick (nausea)
  - being sick (vomiting)
  - diarrhoea
  - constipation
  - stomach pain
  - feeling weak or tired
- these are mainly seen during dose escalation and usually go away over time.

**Common** (may affect up to 1 in 10 people)

- feeling dizzy
- upset stomach or indigestion
- burping
- gas (flatulence)
- bloating of the stomach
- inflamed stomach ('gastritis') – the signs include stomach-ache, feeling sick (nausea) or being sick (vomiting)
- reflux or heartburn – also called 'gastro-oesophageal reflux disease'
- gallstones
- hair loss
- injection site reactions
- low blood sugar (hypoglycaemia) in patients with type 2 diabetes.

The warning signs of low blood sugar may come on suddenly. They can include: cold sweat, cool pale skin, headache, fast heartbeat, feeling sick (nausea) or very hungry, changes in vision, feeling sleepy or weak, feeling nervous, anxious or confused, difficulty concentrating or shaking.

Your doctor will tell you how to treat low blood sugar and what to do if you notice these warning signs.

Low blood sugar is more likely to happen if you also take a sulfonylurea or insulin. Your doctor may reduce your dose of these medicines before you start using this medicine.



**Uncommon** (may affect up to 1 in 100 people)

- low blood pressure
- feeling dizzy or lightheaded on standing or sitting up because of a drop in blood pressure
- fast heartbeat
- increase of pancreatic enzymes (such as lipase and amylase) shown in blood tests
- a delay in the emptying of the stomach.

### **Reporting of side effects**

If you get any side effects, talk to your doctor, pharmacist or nurse. This includes any possible side effects not listed in this leaflet. You can also report side effects directly via the national reporting system listed in [Appendix V](#). By reporting side effects you can help provide more information on the safety of this medicine.

## **5. How to store Wegovy**

Keep this medicine out of the sight and reach of children.

Do not use this medicine after the expiry date which is stated on the pen label and carton after 'EXP'. The expiry date refers to the last day of that month.

Store in a refrigerator (2°C – 8°C). Do not freeze. Keep away from the cooling element. Always store the pen in the original carton in order to protect from light.

Wegovy may be stored unrefrigerated for up to 28 days at a temperature not above 30°C.

Discard the pen if it has been exposed to light or temperatures above 30°C, has been out of the refrigerator for more than 28 days, or has been frozen.

Do not use this medicine if you notice that the solution is not clear and colourless.

After use: The pen is for single use and contains one dose only. Discard pen after use.

Do not throw away any medicines via wastewater or household waste. Ask your pharmacist how to throw away medicines you no longer use. These measures will help protect the environment.

## **6. Contents of the pack and other information**

### **What Wegovy contains**

- The active substance is semaglutide.

#### Wegovy 0.25 mg solution for injection

Each pre-filled pen contains 0.25 mg semaglutide in 0.5 mL (0.5 mg/mL).

#### Wegovy 0.5 mg solution for injection

Each pre-filled pen contains 0.5 mg semaglutide in 0.5 mL (1 mg/mL).

#### Wegovy 1 mg solution for injection

Each pre-filled pen contains 1 mg semaglutide in 0.5 mL (2 mg/mL).

#### Wegovy 1.7 mg solution for injection

Each pre-filled pen contains 1.7 mg semaglutide in 0.75 mL (2.27 mg/mL).

#### Wegovy 2.4 mg solution for injection

Each pre-filled pen contains 2.4 mg of semaglutide in 0.75 mL (3.2 mg/mL).

- The other ingredients are disodium phosphate dihydrate, sodium chloride, hydrochloric acid/sodium hydroxide (for pH adjustment), water for injections. See also section 2 'Wegovy contains sodium' for information on sodium.

**What Wegovy looks like and contents of the pack**

Wegovy is a clear and colourless solution for injection in a pre-filled disposable pen.

Each pen contains one dose only.

Pack size of 4 pre-filled pens.

**Marketing Authorisation Holder and Manufacturer**

Novo Nordisk A/S

Novo Allé

DK-2880 Bagsværd

Denmark

**This leaflet was last revised in**

**Other sources of information**

Detailed information on this medicine is available on the European Medicines Agency web site:  
<http://www.ema.europa.eu>.

Protected by Copyright

**Package leaflet: Information for the patient**

# Wegovy

**0.25 mg** **0.5 mg** **1 mg** **1.7 mg** **2.4 mg**

Wegovy 0.25 mg solution for injection in pre-filled pen  
Wegovy 0.5 mg solution for injection in pre-filled pen  
Wegovy 1 mg solution for injection in pre-filled pen  
Wegovy 1.7 mg solution for injection in pre-filled pen  
Wegovy 2.4 mg solution for injection in pre-filled pen  
**semaglutide**



**Use Wegovy one time each week**



**Pull out to get started**

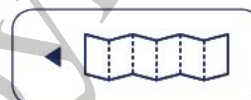

## **Instructions on how to use Wegovy pen**

### **Important information before you start**

The package contains one package leaflet and four Wegovy pre-filled pens.

This part of the package leaflet instructs on how to use the pen. For further information regarding your medicine please refer to the other side of this package leaflet.

Each pen is only to be used once.

It comes with:

- **one pre-set dose.**
- **a needle cover** that hides the built-in needle before, during and after use.
- **an automatic dosing** mechanism that starts when the needle cover is pressed against your skin as described by your doctor or nurse.

When injecting the dose, a yellow bar will appear in the pen window. Do not lift the pen before the yellow bar has stopped moving. If you do, the automatic dosing will continue, but you may not receive your full dose.

The needle cover will lock when the pen is removed from your skin. You cannot pause the injection and restart it later.

People who are blind or have vision problems should not use Wegovy pen without help from a person trained to use Wegovy.

Always follow these user instructions and any directions given by your doctor or nurse.

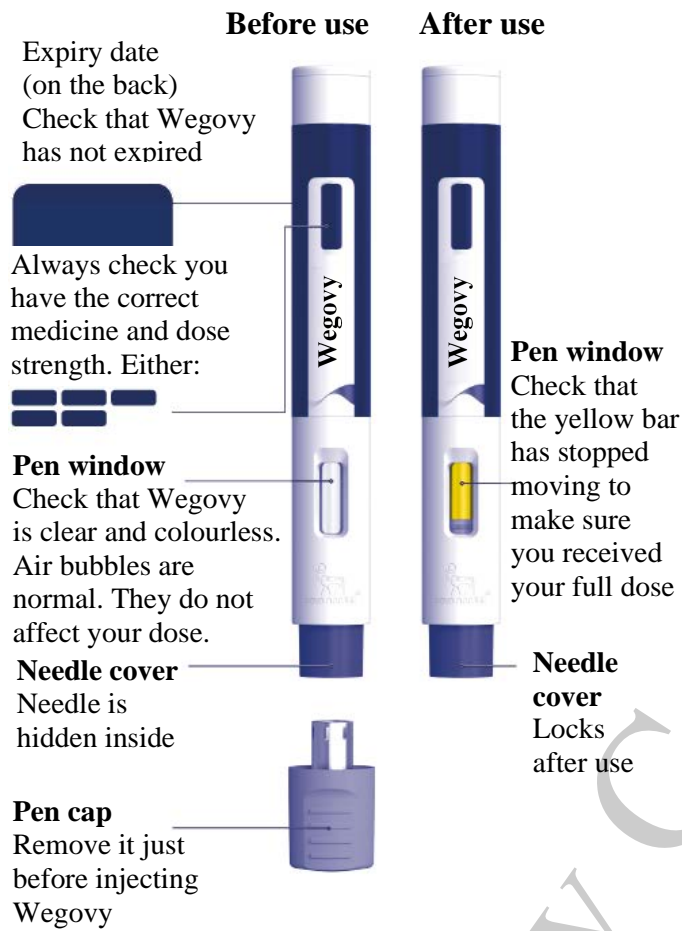

EXP/ XX/XXXX  
Batch: AB1234

- 0.25 mg
- 0.5 mg
- 1 mg
- 1.7 mg
- 2.4 mg

## How to use your Wegovy

### 1. Prepare for your injection.

Check your Wegovy pen and be careful not to use your pen if:

1. it has expired
2. it appears to have been used or damaged, e.g. if it has been dropped or stored incorrectly
3. the medicine looks cloudy.

### Choose your injection site

Choose an injection site in one of the body areas marked below. You can choose your upper arms, upper legs or stomach (keep a 5 cm distance from your belly button).

You may inject in the same body area each week, but make sure it is not in the same spot as used the last time.

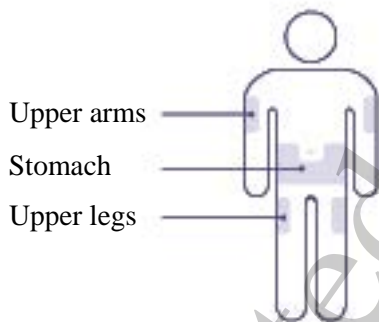

### 2. Remove pen cap.

Pull the pen cap straight off your pen.





### How do I handle my pen safely?

For information regarding your medicine please refer to the other side of this package leaflet.

- The pen is for a single injection of Wegovy under the skin once a week and should be used by one person only.
- Always refer to the instructions on the other side of this package leaflet and ensure you have been shown how to use these pens by your doctor or nurse.
- Always keep Wegovy pens out of sight and reach of children. Also, keep the pen cap away from children to prevent them from swallowing it.
- Treat your pen with care and do not expose it to any kind of liquid. Rough handling or misuse may cause your pen to give less than the full dose or no dose at all.

- Keep the pen cap on until you are ready to inject. Your pen will no longer be sterile if you store an unused pen without the cap, if you pull the pen cap off and put it on again, or if the pen cap is missing. This could lead to an infection.
- Be careful when handling your pen before use and do not touch the needle or the needle cover. The hidden needle can cause needle stick injuries.
- Each pen contains one weekly dose and cannot be reused. Dispose of it after use.

**How do I store my unused pens?**

For information regarding storage see section 5 on the other side of this package leaflet.

**How do I dispose of my pens?**

Do not throw away any medicines via wastewater or household waste. Ask your pharmacist how to throw away medicines you no longer use. These measures will help protect the environment.

Protected by Copyright

### Package leaflet: Information for the patient

**Wegovy 0.25 mg FlexTouch solution for injection in pre-filled pen**  
**Wegovy 0.5 mg FlexTouch solution for injection in pre-filled pen**  
**Wegovy 1 mg FlexTouch solution for injection in pre-filled pen**  
**Wegovy 1.7 mg FlexTouch solution for injection in pre-filled pen**  
**Wegovy 2.4 mg FlexTouch solution for injection in pre-filled pen**  
semaglutide

▼ This medicine is subject to additional monitoring. This will allow quick identification of new safety information. You can help by reporting any side effects you may get. See the end of section 4 for how to report side effects.

**Read all of this leaflet carefully before you start using this medicine because it contains important information for you.**

- Keep this leaflet. You may need to read it again.
- If you have any further questions, ask your doctor, pharmacist or nurse.
- This medicine has been prescribed for you only. Do not pass it on to others. It may harm them, even if their signs of illness are the same as yours.
- If you get any side effects, talk to your doctor, pharmacist or nurse. This includes any possible side effects not listed in this leaflet. See section 4.

#### What is in this leaflet

1. What Wegovy is and what it is used for
2. What you need to know before you use Wegovy
3. How to use Wegovy
4. Possible side effects
5. How to store Wegovy
6. Contents of the pack and other information

#### 1. What Wegovy is and what it is used for

##### What Wegovy is

Wegovy is a medicine for weight loss and weight maintenance that contains the active substance semaglutide. It is similar to a natural hormone called glucagon-like peptide-1 (GLP-1) that is released from the intestine after a meal. It works by acting on targets (receptors) in the brain that control your appetite, causing you to feel fuller and less hungry and experience less craving for food. This will help you eat less food and reduce your body weight.

##### What Wegovy is used for

Wegovy is used together with diet and physical activity for weight loss and to help keep the weight under control. It is used in adults, who have

- a BMI of 30 kg/m<sup>2</sup> or greater (obesity) or
- a BMI of at least 27 kg/m<sup>2</sup> but less than 30 kg/m<sup>2</sup> (overweight) who have weight-related health problems (such as diabetes, high blood pressure, abnormal levels of fats in the blood, breathing problems during sleep called 'obstructive sleep apnoea' or a history of heart attack, stroke or blood vessel problems).

BMI (Body Mass Index) is a measure of your weight in relation to your height.

Wegovy is used together with diet and physical activity for weight management in adolescents ages 12 years and above, who have

- obesity and
- body weight >60 kg.



As an adolescent patient, you should only continue using Wegovy if you have lost at least 5% of your BMI after 12 weeks on the 2.4 mg dose or maximum tolerated dose (see section 3). Consult your doctor before you continue.

## 2. What you need to know before you use Wegovy

### Do not use Wegovy

- if you are allergic to semaglutide or any of the other ingredients of this medicine (listed in section 6).

### Warnings and precautions

Talk to your doctor, pharmacist or nurse before using Wegovy.

The use of Wegovy is not recommended if you:

- use other products for weight loss,
- have type 1 diabetes,
- have severely reduced kidney function,
- have severely reduced liver function,
- have severe heart failure,
- have diabetic eye disease (retinopathy).

There is little experience with Wegovy in patients:

- of 75 years and older,
- with liver problems,
- with severe stomach or gut problem which results in delayed stomach emptying (called gastroparesis), or if you have an inflammatory bowel disease.

Please consult your doctor if one of the above applies to you.

- **Dehydration**

During treatment with Wegovy, you may feel sick (nausea) or be sick (vomiting), or have diarrhoea. These side effects can cause dehydration (loss of fluids). It is important that you drink enough fluids to prevent dehydration. This is especially important if you have kidney problems. Talk to your doctor if you have any questions or concerns.

- **Inflammation of the pancreas**

If you have severe and on-going pain in the stomach area (see section 4) – see a doctor straight away as this could be a sign of inflamed pancreas (acute pancreatitis).

- **People with type 2 diabetes**

Wegovy cannot be used as a substitute for insulin. Do not use Wegovy in combination with other medicines that contain GLP-1 receptor agonists (such as liraglutide, dulaglutide, exenatide or lixisenatide).

- **Low blood sugar (hypoglycaemia)**

Taking a sulfonylurea or an insulin with Wegovy might increase the risk of getting low blood sugar levels (hypoglycaemia). Please see section 4 for the warning signs of low blood sugar levels. Your doctor may ask you to test your blood sugar levels. This will help your doctor decide if the dose of the sulfonylurea or insulin needs to be changed to reduce the risk of low blood sugar.

- **Diabetic eye disease (retinopathy)**

If you have diabetic eye disease and are using insulin, this medicine may lead to a worsening of your vision, and this may require treatment. Fast improvements in blood sugar control may lead to a temporary worsening of diabetic eye disease. If you have diabetic eye disease and experience eye problems while taking this medicine, talk to your doctor.

### **Children and adolescents**

The safety and efficacy of Wegovy in children below 12 years of age have not been studied and are not recommended for use in this population.

### **Other medicines and Wegovy**

Tell your doctor, pharmacist or nurse if you are using, have recently used or might use any other medicines.

In particular, tell your doctor, pharmacist or nurse if you are using medicines containing the following:

- Warfarin or other similar medicines taken by mouth to reduce blood clotting (oral anti-coagulants). When you start treatment with e.g. warfarin or similar medicines, frequent blood testing to determine the ability of your blood to clot may be required.

### **Pregnancy and breast-feeding**

This medicine should not be used during pregnancy, as it is not known if it may affect your unborn child. Therefore, it is recommended to use contraception while using this medicine. If you wish to become pregnant, you should stop using this medicine at least two months in advance. If you become or are pregnant, think you may be pregnant or are planning to have a baby when using this medicine, talk to your doctor straight away, as your treatment will need to be stopped.

Do not use this medicine if you are breast-feeding, as it is unknown if it passes into breast milk.

### **Driving and using machines**

Wegovy is unlikely to affect your ability to drive and use machines. Some patients may feel dizzy when taking Wegovy mainly during the first 4 months of treatment (see section 4). If you feel dizzy be extra careful while driving or using machines. If you need any further information, talk to your doctor, pharmacist or nurse.

#### *People with type 2 diabetes*

If you use this medicine in combination with a sulfonylurea or insulin, low blood sugar (hypoglycaemia) may occur which may reduce your ability to concentrate. Avoid driving or using machines if you get any signs of low blood sugar. See section 2, 'Warnings and precautions' for information on increased risk of low blood sugar and section 4 for the warning signs of low blood sugar. Talk to your doctor for further information.

### **Wegovy contains sodium**

This medicine contains less than 1 mmol sodium (23 mg) per dose, that is to say essentially 'sodium-free'.

## **3. How to use Wegovy**

Always use this medicine exactly as your doctor has told you. Check with your doctor, pharmacist or nurse if you are not sure.

### **How much to use**

#### *Adults*

The recommended dose is 2.4 mg once weekly.

Your treatment will start at a low dose which will be gradually increased over 16 weeks of treatment.

- When you first start using Wegovy, the starting dose is 0.25 mg once weekly.
- Your doctor will instruct you to gradually increase your dose every 4 weeks until you reach the recommended dose of 2.4 mg once weekly.
- Once you reach the recommended dose of 2.4 mg, do not increase this dose further.
- In case you are feeling very bothered by sickness (nausea) or by being sick (vomiting) talk with your doctor about delaying dose escalation or lowering to the previous dose until symptoms have improved.

Usually, you will be told to follow the table below.

Dose escalation	Weekly dose
Week 1–4	0.25 mg
Week 5–8	0.5 mg
Week 9–12	1 mg
Week 13–16	1.7 mg
From week 17	2.4 mg

Your doctor will assess your treatment on a regular basis.

#### *Adolescents (above 12 years of age)*

For adolescents, the same dose escalation schedule as for adults should be applied (see above). The dose should be increased until 2.4 mg (maintenance dose) or maximum tolerated dose has been reached. Weekly doses higher than 2.4 mg are not recommended.

#### **How Wegovy is given**

Wegovy is given as an injection under the skin (subcutaneous injection). Do not inject it into a vein or muscle.

- The best places to give the injection are the front of your upper arm, upper legs or stomach.
- Before you use the pen for the first time, your doctor, pharmacist or nurse will show you how to use it.

Detailed instructions on how to use the pen are on the other side of this leaflet.

#### **People with type 2 diabetes**

Tell your doctor if you have type 2 diabetes. Your doctor may adjust the dose of your diabetes medicines to prevent you from getting low blood sugar.

#### **When to use Wegovy**

- You should use this medicine once a week and if possible, on the same day each week.
- You can give yourself the injection at any time of the day – regardless of meals.

If necessary, you can change the day of your weekly injection of this medicine as long as it has been at least 3 days since your last injection. After selecting a new dosing day, continue with once a week dosing.

#### **If you use more Wegovy than you should**

Talk to your doctor straight away. You may get side effects such as feeling sick (nausea), being sick (vomiting) or have diarrhoea, which may cause dehydration (loss of fluids).

#### **If you forget to use Wegovy**

If you forgot to inject a dose and:

- it is 5 days or less since you should have used Wegovy, use it as soon as you remember. Then inject your next dose as usual on your scheduled day.
- it is more than 5 days since you should have used Wegovy, skip the missed dose. Then inject your next dose as usual on your next scheduled day.

Do not use a double dose to make up for a forgotten dose.

#### **If you stop using Wegovy**

Do not stop using this medicine without talking to your doctor.

If you have any further questions on the use of this medicine, ask your doctor, pharmacist or nurse.

#### 4. Possible side effects

Like all medicines, this medicine can cause side effects, although not everybody gets them.

##### Serious side effects

**Common** (may affect up to 1 in 10 people)

- Complications of diabetic eye disease (diabetic retinopathy). If you have diabetes you should inform your doctor if you experience eye problems, such as changes in vision, during treatment with this medicine.

**Uncommon** (may affect up to 1 in 100 people)

- Inflamed pancreas (acute pancreatitis). Signs of inflamed pancreas may include severe and long-lasting pain in your stomach, the pain may move to your back. You should see your doctor immediately if you experience such symptoms.

**Rare** (may affect up to 1 in 1,000 people)

- Severe allergic reactions (anaphylactic reactions, angioedema). You should seek immediate medical help and inform your doctor straight away if you get symptoms such as breathing difficulty, swelling, light-headedness, fast heartbeat, sweating and loss of consciousness or rapid swelling under the skin in areas such as the face, throat, arms and legs, which can be life threatening if throat swelling blocks the airway.

##### Other side effects

**Very common** (may affect more than 1 in 10 people)

- headache
  - feeling sick (nausea)
  - being sick (vomiting)
  - diarrhoea
  - constipation
  - stomach pain
  - feeling weak or tired
- these are mainly seen during dose escalation and usually go away over time.

**Common** (may affect up to 1 in 10 people)

- feeling dizzy
- upset stomach or indigestion
- burping
- gas (flatulence)
- bloating of the stomach
- inflamed stomach ('gastritis') – the signs include stomach-ache, feeling sick (nausea) or being sick (vomiting)
- reflux or heartburn – also called 'gastro-oesophageal reflux disease'
- gallstones
- hair loss
- injection site reactions
- low blood sugar (hypoglycaemia) in patients with type 2 diabetes.

The warning signs of low blood sugar may come on suddenly. They can include: cold sweat, cool pale skin, headache, fast heartbeat, feeling sick (nausea) or very hungry, changes in vision, feeling sleepy or weak, feeling nervous, anxious or confused, difficulty concentrating or shaking.

Your doctor will tell you how to treat low blood sugar and what to do if you notice these warning signs.

Low blood sugar is more likely to happen if you also take a sulfonylurea or insulin. Your doctor may reduce your dose of these medicines before you start using this medicine.

**Uncommon** (may affect up to 1 in 100 people)

- low blood pressure
- feeling dizzy or lightheaded on standing or sitting up because of a drop in blood pressure
- fast heartbeat
- increase of pancreatic enzymes (such as lipase and amylase) shown in blood tests
- a delay in the emptying of the stomach.

**Reporting of side effects**

If you get any side effects, talk to your doctor, pharmacist or nurse. This includes any possible side effects not listed in this leaflet. You can also report side effects directly via the national reporting system listed in [Appendix V](#). By reporting side effects you can help provide more information on the safety of this medicine.

**5. How to store Wegovy**

Keep this medicine out of the sight and reach of children.

Do not use this medicine after the expiry date which is stated on the pen label and carton after 'EXP'. The expiry date refers to the last day of that month.

**Before opening**

Store in a refrigerator (2°C – 8°C). Do not freeze. Keep away from the cooling element.

**During use**

- You can keep the pen for 6 weeks when stored at a temperature below 30°C or in a refrigerator (2°C – 8°C) away from the cooling element. Do not freeze Wegovy and do not use it if it has been frozen.
- When you are not using the pen, keep the pen cap on in order to protect from light.

Do not use this medicine if you notice that the solution is not clear and colourless.

Do not throw away any medicines via wastewater or household waste. Ask your pharmacist how to throw away medicines you no longer use. These measures will help protect the environment

**6. Contents of the pack and other information**

**What Wegovy contains**

- The active substance is semaglutide.

Wegovy 0.25 mg FlexTouch solution for injection

Each pre-filled pen contains 1 mg semaglutide in 1.5 mL (0.68 mg/mL).

Wegovy 0.5 mg FlexTouch solution for injection

Each pre-filled pen contains 2 mg semaglutide in 1.5 mL (1.34 mg/mL).

Wegovy 1 mg FlexTouch solution for injection

Each pre-filled pen contains 4 mg semaglutide in 3 mL (1.34 mg/mL).

Wegovy 1.7 mg FlexTouch solution for injection

Each pre-filled pen contains 6.8 mg semaglutide in 3 mL (2.27 mg/mL).

Wegovy 2.4 mg FlexTouch solution for injection

Each pre-filled pen contains 9.6 mg of semaglutide in 3 mL (3.2 mg/mL).

- The other ingredients are disodium phosphate dihydrate, propylene glycol, phenol, hydrochloric acid/sodium hydroxide (for pH adjustment), water for injections. See also section 2 'Wegovy contains sodium' for information on sodium.

### **What Wegovy looks like and contents of the pack**

Wegovy is a clear and colourless solution for injection in a pre-filled pen.

Each pre-filled pen contains 4 doses.

Wegovy 0.25, 0.5, 1 and 1.7 mg FlexTouch solution for injection is available in the following pack size:

1 pre-filled pen and 4 disposable NovoFine Plus needles.

Wegovy 2.4 mg FlexTouch solution for injection is available in the following pack sizes:

1 pre-filled pen and 4 disposable NovoFine Plus needles.

3 pre-filled pens and 12 disposable NovoFine Plus needles

Not all pack sizes may be marketed.

### **Marketing Authorisation Holder**

Novo Nordisk A/S  
Novo Allé  
DK-2880 Bagsværd  
Denmark

### **Manufacturer**

Novo Nordisk A/S  
Novo Allé  
DK-2880 Bagsværd  
Denmark

Novo Nordisk Production SAS  
45, Avenue d'Orléans  
28000 Chartres  
France

### **This leaflet was last revised in**

### **Other sources of information**

Detailed information on this medicine is available on the European Medicines Agency web site:  
<http://www.ema.europa.eu>.

## Instructions on how to use Wegovy

Before you begin using your once-weekly Wegovy FlexTouch pen, **always read these instructions carefully**, and talk to your doctor, nurse or pharmacist about how to inject Wegovy correctly.

Wegovy pen is a dial-a-dose pen that **contains four of your prescribed doses of Wegovy, corresponding to four times of once-weekly use.**

Please use the table inside the lid of the carton to keep track of how many injections you have used and how many doses remain in your pen.

Wegovy comes in five different pens, each containing one of the following prescribed doses of semaglutide:

0.25 mg

0.5 mg

1 mg

1.7 mg

2.4 mg

**Always start by checking your pen label to make sure that it contains your prescribed dose of Wegovy.**

Your pen is designed to be used with 30G, 31G, and 32G disposable needles up to a length of 8 mm.

### The pack contains:

- Wegovy pen
- 4 NovoFine Plus needles
- Package leaflet

### Wegovy FlexTouch pen (example)

**Please note:** Your pen may differ in size and your pen label may differ in colour from the example shown in the pictures.  
These instructions apply to all Wegovy FlexTouch pens

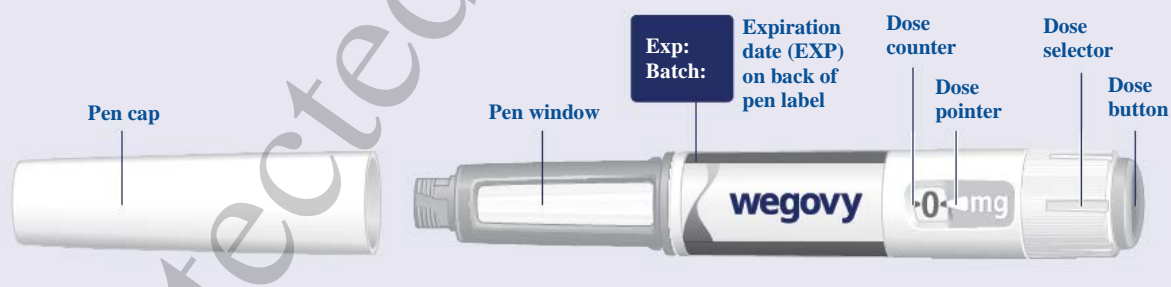

### NovoFine Plus needle (example)

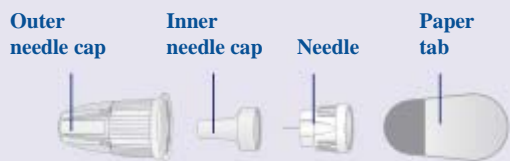

#### 1 Prepare your pen with a new needle

**Check the name and dose** of your pen to make sure it contains your prescribed dose of Wegovy.

**Pull off the pen cap.**

(See figure A).

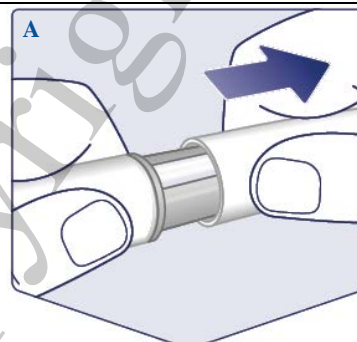

**Check that the solution in your pen is clear and colourless.**

Look through the pen window. If Wegovy looks cloudy or coloured, do not use the pen.

(See figure B).

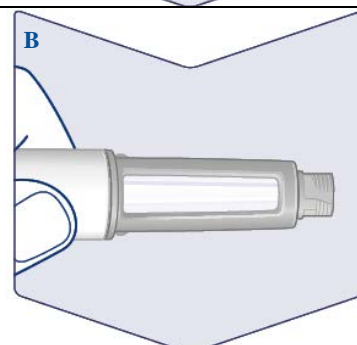

**Always use a new needle for each injection.**

**Take a needle** when you are ready to take your injection. Check the paper tab and the outer needle cap for damages that could affect sterility. If any damage is seen, use a new needle.

**Tear off the paper tab.**

(See figure C).

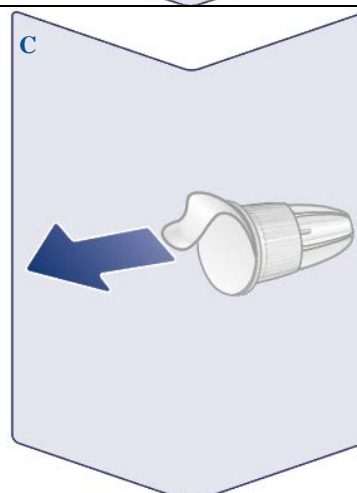

**Push the needle straight onto the pen. Turn until it is on tight.**

(See figure D).

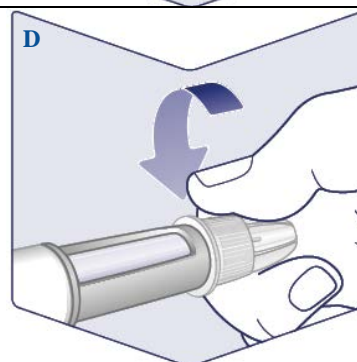



**The needle is covered by two caps. You must remove both caps.** If you forget to remove both caps you will not inject any Wegovy.

**Pull off the outer needle cap and keep it for later.** You will need it to safely remove the needle from the pen after the injection.

**Pull off the inner needle cap and dispose of it.** A drop of Wegovy may appear at the needle tip. You must still check the Wegovy flow if you use a new pen for the first time. See '**Check the flow with each new pen**'.

Never use a bent or damaged needle. For more information about needle handling, see '**About your needles**' below these instructions.

(See figure E).

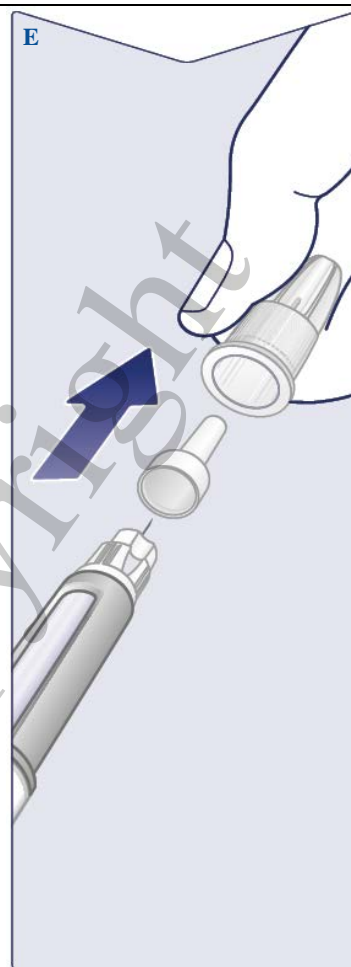

**Check the flow with each new pen**

If your Wegovy pen is already in use, go to '**2 Set your dose**'.

Only check the Wegovy flow before your **first injection with each new pen**.

Turn the dose selector until you see the flow check symbol (■ ■ ▬).

(See figure F).



Make sure the flow check symbol lines up with the dose pointer.

(See figure G).



### Check the flow

Hold the pen with the needle pointing up.

**Press and hold in the dose button** until the dose counter returns to **0.0**. The **0.0** must line up with the dose pointer.

A drop of Wegovy should appear at the needle tip. This drop indicates that your pen is ready for use.

If a drop does not appear, check the flow again. **This should only be done twice.**

If there is still no drop, **change the needle and check the flow once more.**

**Do not use the pen** if a drop of Wegovy still does not appear.

(See figure H).



## 2 Set your dose

Turn the dose selector until the **dose counter stops**, and it **shows your prescribed dose**.

(See figure I).

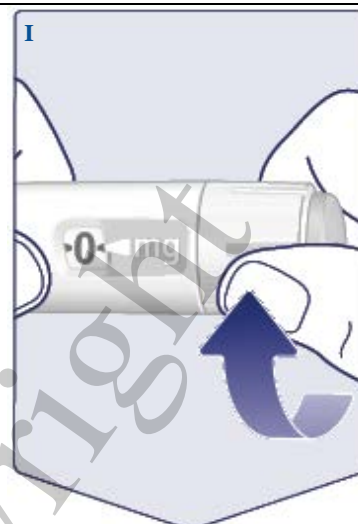

The dashed line (|) in the dose counter will guide you to your dose.

The dose selector clicks differently when turned forward, backwards or past your dose. You will hear a 'click' every time you turn the dose selector. Do not set the dose by counting the number of clicks you hear.

(See figure J).

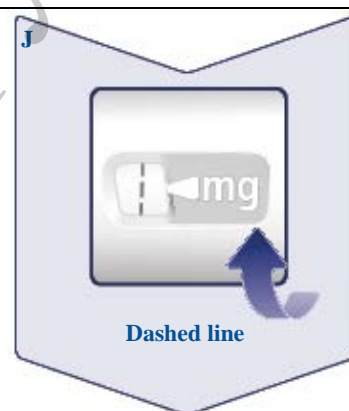

**When your prescribed dose lines up with the dose pointer, you have selected your dose.** In this picture, the dose **0.25 mg** is shown as an example.

If the dose counter stops before you reach your prescribed dose, see the section **'Do you have enough Wegovy?'** below these instructions.

(See figure K).

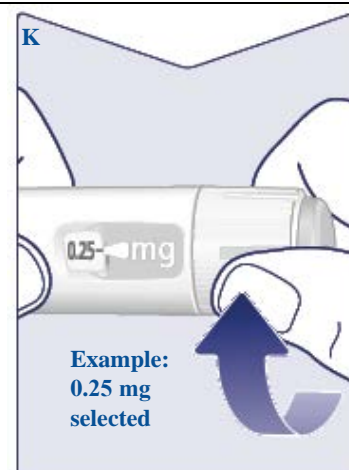

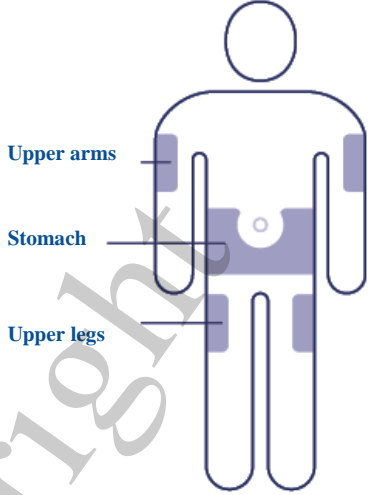
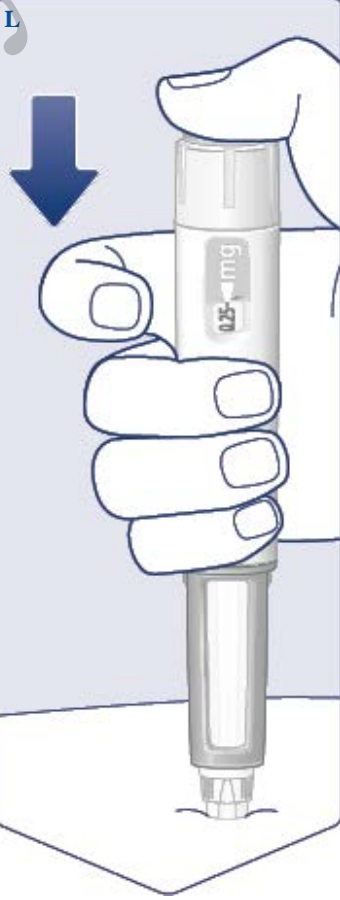
<p><b>Choose your injection site</b></p> <p>Choose your upper arms, upper legs or stomach (keep a 5 cm distance from your belly button).</p> <p>You may inject in the same body area each week, but make sure it is not in the same spot as used the last time.</p>	 <p>Upper arms</p> <p>Stomach</p> <p>Upper legs</p>
<p><b>3 Inject your dose</b></p> <p><b>Insert the needle into your skin.</b></p> <p><b>Make sure you can see the dose counter.</b> Do not cover it with your fingers. This could interrupt the injection.</p> <p>(See figure L).</p>	<p>L</p> 

**Press and hold down the dose button until the dose counter shows 0.**

(See figure M).

**Keep pressing the dose button with the needle in your skin and slowly count to 6.** The 0 must line up with the dose pointer. You may hear or feel a click when the dose counter returns to 0.

(See figure N).

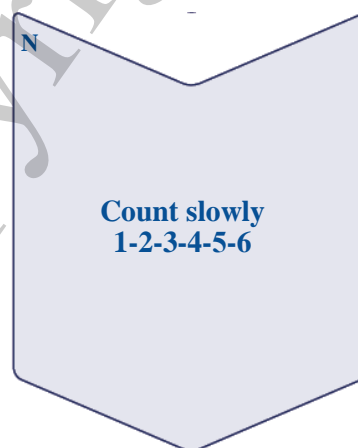

**Remove the needle from your skin.** If the needle is removed earlier, a stream of Wegovy may come from the needle tip and the full dose will not be delivered.

If blood appears at the injection site, press lightly on the area to stop the bleeding.

You may see a drop of Wegovy at the needle tip after injecting. This is normal and does not affect your dose.

(See figure O).

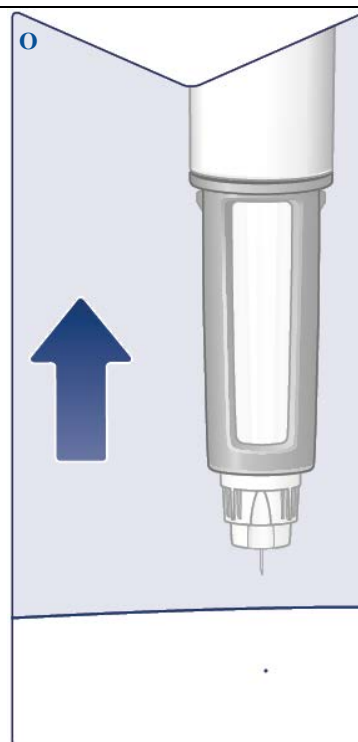

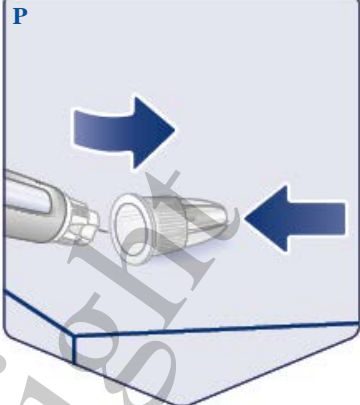
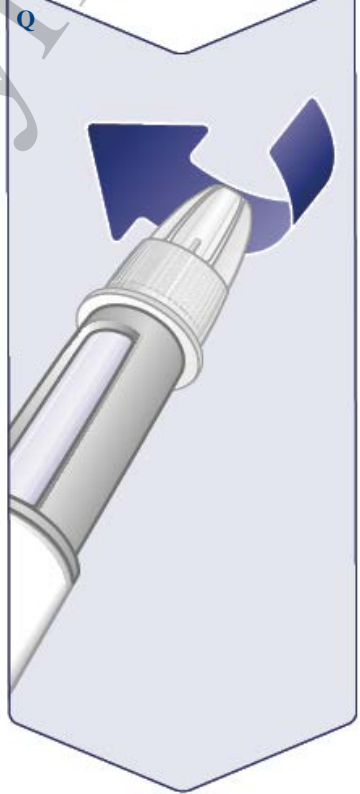
<p><b>4 After your injection</b></p> <p><b>Lead the needle tip into the outer needle cap</b> on a flat surface without touching the needle or the outer needle cap.</p> <p><b>Once the needle is covered,</b> carefully push the outer needle cap completely on.</p> <p>(See figure P).</p>	<p>P</p> 
<p><b>Unscrew the needle</b> and dispose of it carefully as instructed by your doctor, nurse, pharmacist or local authorities.</p> <p><b>Never try to put the inner needle cap back on the needle.</b> You may stick yourself with the needle.</p> <p><b>Always dispose of the needle immediately after each injection</b> to prevent blocked needles, contamination, infection, and inaccurate dosing. <b>Never store your pen with the needle attached.</b></p> <p>(See figure Q).</p>	<p>Q</p> 

<p><b>Put the pen cap on</b> your pen after each use to protect Wegovy from light.</p> <p>(See figure R).</p>	<p>R</p> 
<p>When the pen is empty, dispose of the pen without a needle on as instructed by your doctor, nurse, pharmacist, or local authorities.</p> <p>The pen cap and the empty carton can be disposed of in your household waste.</p>	
<p><b>About your needles</b></p>	
<p><b>How to identify a blocked or damaged needle</b></p> <ul style="list-style-type: none"><li>• If <b>•0•</b> does not appear in the dose counter after continuously pressing the dose button, you may have used a blocked or damaged needle.</li><li>• In this case, you have <b>not</b> received any Wegovy – even though the dose counter has moved from the original dose that you have set.</li></ul> <p><b>How to handle a blocked needle</b></p> <ul style="list-style-type: none"><li>• Change the needle as instructed in ‘<b>1 Prepare your pen with a new needle</b>’ and go to ‘<b>2 Set your dose</b>’.</li></ul>	

### Caring for your pen

Treat your pen with care. Rough handling or misuse may cause inaccurate dosing. If this happens, you might not get the intended effect of Wegovy.

- See the back of this leaflet to read the storage conditions for your pen.
- **Do not inject Wegovy that has been exposed to direct sunlight.**
- **Do not subject Wegovy to frost and never inject Wegovy that has been frozen.** Dispose of the pen.
- **Do not drop your pen** or knock it against hard surfaces.
- **Do not try to refill your pen.** Once empty, it must be disposed of.
- **Do not try to repair your pen** or pull it apart.
- **Do not expose your pen to dust, dirt or liquid.**
- **Do not wash, soak or lubricate your pen.** If necessary, clean it with a mild detergent on a moistened cloth.

### Do you have enough Wegovy?

If the dose counter stops before you reach your prescribed dose, there is not enough Wegovy left for a full dose. Dispose of the pen and use a new Wegovy pen.

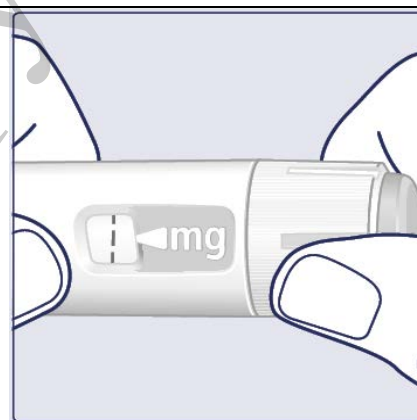

### Important information

- **Only inject one dose of Wegovy once weekly.** If you do not use your Wegovy as prescribed, you may not get the intended effect of this medicine.
- If you use more than one type of injectable medicine, it is very **important to check the name and dose** of your pen label **before use**.
- **Do not use this pen without help if you have poor eyesight and cannot follow these instructions.** Get help from a person with good eyesight who is trained to use the Wegovy pen.
- Always keep pen and needles **out of sight and reach of others, especially children.**
- **Never share** your pen or your needles with other people.
- **Needles are for single use only. Never reuse your needles** as it may lead to blocked needles, contamination, infection and inaccurate dosing.
- Caregivers must **be very careful when handling used needles** to prevent accidental needle stick injuries and infection.